

PCM 125/125 G



Sample image

Order symbol : PCM 125/125 G

EAN : 6418074038067

Product nr : 6016310

El. number :

Description : Enclosure, PC, metric knock-outs

- Finland : 3421638
- Denmark : 8212027129
- Sweden : 2535321

Remarks : Grey cover

Including : Base with TPE gasket. screws for mounting plate/DIN-rail and cover with polyamide cover screws.

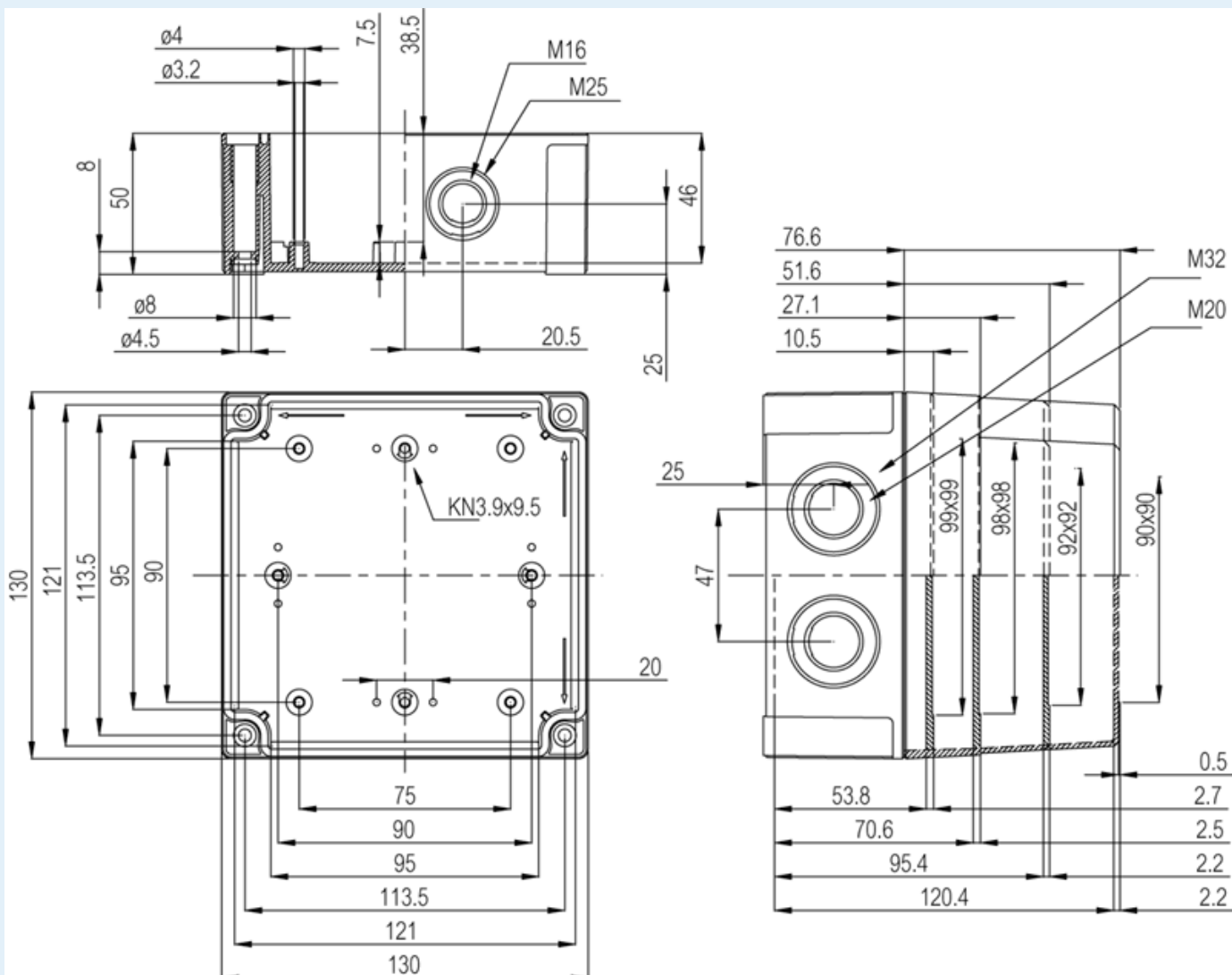

Dimensions :	Height	Width	Depth
mm :	130	130	125
inch :	5.12	5.12	4.92

Materials :

Material :	Polycarbonate
Base colour :	RAL_7035
Cover colour :	RAL 7035 -light grey
Gasket material :	TPE

Temperatures :

Temperature °C (continuous) :	-40 ... 80
Temperature °F (continuous) :	-40 ... 175

Accessories :

MIV 10	DIN-35 Mounting rail, for enclosures: (100 x 35 x 7.5)
HFP 130	Front plate hinge series
FP A 125/ 130	Front plate (Aluminium), for enclosures: (120 x 112 x 1)
MIN 10	DIN-15 Mounting rail, for enclosures:
FP 22046	Wall fastening lug (4 pcs) (35 x 16 x 10)
MIV 125	Mounting plate (Galvanized steel), for enclosures: (98 x 98 x 1.5)

Ratings :

Ingress protection (EN 60529):	IP66; IP67;
Impact Resistance (EN 62262):	IK08;
electrical_insulation :	Totally insulated
Halogen free (DIN/VDE 0472, Part 815) :	Yes
UV resistance :	UL 746C
Flammability Rating :	UL 94 V0
Glow Wire Test (IEC 695-2-1) °C :	960C

Certificates :

Certificate FI 40847