



VX IT

The solution for all network and server applications

Whether you need a network rack to house a corridor distributor, or server racks for an edge, cloud or hyperscale data centre, the new VX IT provides the ideal platform and meets all the requirements of a modern IT infrastructure.

Consistent customer focus

The new VX IT is based on a modular concept with a customer-friendly configurator to guide you quickly and easily to a solution that is tailored to your individual requirements. A state-of-the-art production line and optimised logistics ensure fast availability and on-time delivery.

Matching modules

The new VX IT provides the basis for RiMatrix Next Generation, the latest generation to have evolved from our extremely popular Rittal IT system, now with numerous new features and innovative products.

Seamless compatibility

A data centre infrastructure will outlive its individual servers. Compatibility with established RiMatrix systems is therefore crucial. The VX IT and RiMatrix NG are therefore ideal for extending existing data centres and replacing individual components.

Future-proof

We stay abreast of the latest trends and understand what drives experts and companies, enabling us to deliver forward-looking solutions. The VX IT, like the RiMatrix NG, are continuously being refined to keep pace with the challenges of an evolving IT infrastructure.

Comprehensive modular system

For all requirements



Versatility for every application

- Even the standard variants are available in up to 28 sizes (EU series) – 2 widths, 6 heights and 4 depths.
- Select your individual 482.6 mm (19") installation to meet your specific requirements from a comprehensive range of racks, components and accessories plus two different load classes (dynamic or standard, as per the detailed rack specifications) and your chosen 482.6 mm (19") interior installation variant, with maximum load limits of 15,000 N or 18,000 N.

Tailored door concept

The choice of door depends on the spatial conditions and your individual requirements with regard to access, climate control and protection category.

- The new 180° hinge ensures a maximum door opening angle even when bayed plus a large-scale handle system including security lock with profile half-cylinder.
- There is a door to suit every climate control system, be it rack, suite or room cooling.
- New options include an automatic door opener to provide emergency cooling or to ensure rack extinguishing with a gas-based room extinguisher system.
- Glazed doors are available for an optimum view or to ensure a closed climate control zone in conjunction with high-performance cooling applications, such as high-capacity heat exchangers.

Roof concept with the required protection category

The choice of roof solution will depend on your planned cable entry and prescribed protection category, for example:

- One-piece, solid, with a protection category of up to IP 55
- With brush strip on both sides across the entire enclosure depth
- Cable entry via brush strip horizontally at the rear, across the entire enclosure width
- Cable entry in the corner zones via brush strips

User-friendly side panel solutions

Your choice of side panel will depend on the required level of access and the prescribed security and protection category parameters, for example:

- For individual enclosures: Optionally one-piece, multi-piece, horizontally divided, plug-in or vertically divided, hinged
- To finish off an enclosure suite: Multi-piece, screw-fastened or partitions, one-piece, slide-in fixing for physical separation of individual enclosures within an enclosure suite

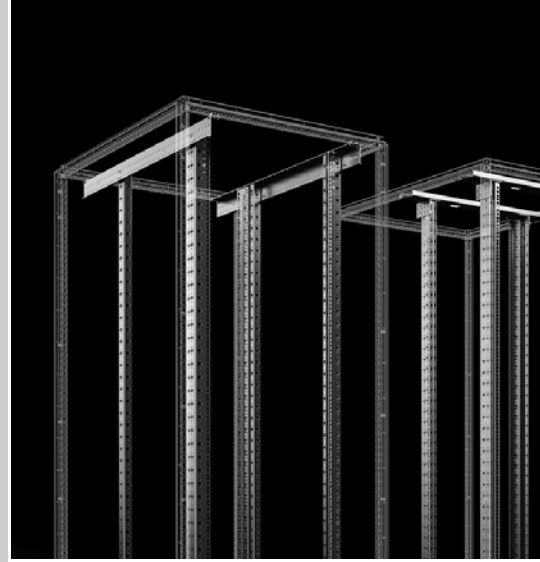

High load capacity

With maximum flexibility



Flexible 482.6 mm (19") installation

Choose from two 482.6 mm (19") installation systems to suit your requirements:

- Standard – Load capacity up to a maximum of 15,000 N or 12,000 N to UL 2416
- Dynamic – Load capacity up to a maximum of 18,000 N or 15,000 N to UL 2416
- Different installation concepts are available for the 482.6 mm (19") mounting angles, depending on the enclosure dimensions. While 600 mm wide racks are mounted directly onto the enclosure frame, in 800 mm wide racks the 482.6 mm (19") levels are mounted on depth stays or cross-members. In this way, alternative mounting dimensions of 21", 23" and 24" are readily accommodated in the enclosure width 800 mm, as are asymmetrical arrangements of the 482.6 mm (19") mounting level. The standard installation variant with cross-members is used with rack depths of up to 800 mm and is ideally suited for use as a network distributor by supporting fast, simple cable management across the entire enclosure width in any height unit.
- An asymmetrical arrangement of the 482.6 mm (19") level gains additional installation space on one side which may be used for optimised cable routing or to integrate a Liquid Cooling Unit (LCU).

Easily extend your existing systems

- The VX IT is also compatible with all existing IT infrastructure solutions assembled with the TS IT and DK TS systems – in other words, further configuration and baying are easily achieved with the VX IT.
- The new baying variant with 3 mm baying gap means that entire racks or liquid cooling packages are easily extracted from the enclosure suite and replaced with updated hardware.

Converting to VX IT couldn't be simpler

- Our smart conversion assistant, available on the Rittal website, allows you to easily convert your existing enclosure systems to the new VX IT system.

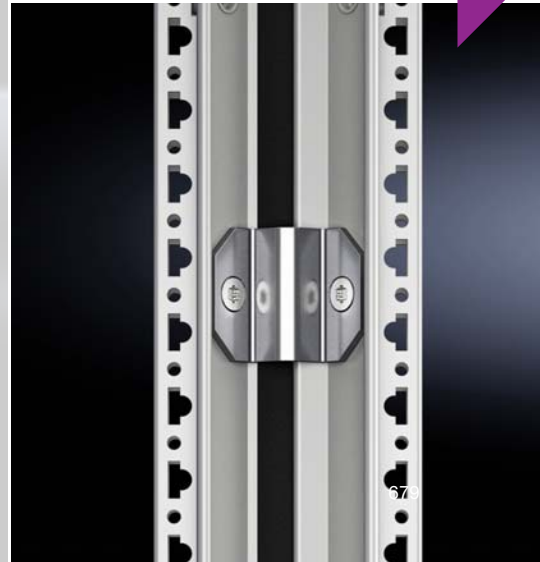
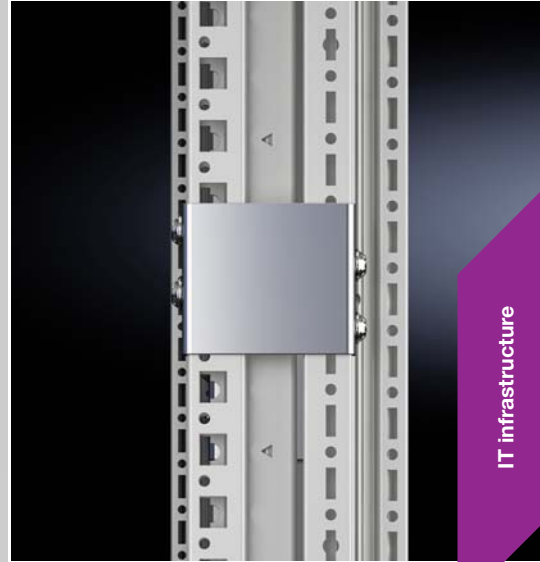
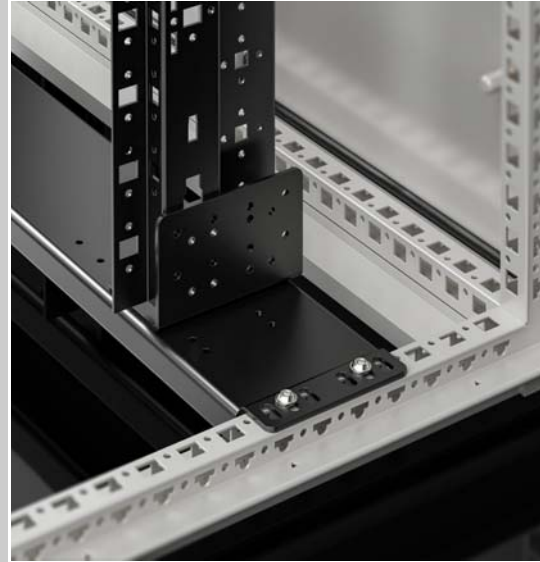

Security and ease of use

Customised at all levels



Roof

- A broad spectrum of individual roof solutions
- Ideal solutions for secure, simple cable entry, even with high cable volumes
- Closed variants for a high protection category of IP 55



Walls

- Divided side panels for problem-free one-man assembly
- Vertically divided, hinged side panels for easy access without dismantling the side panel
- Side panels latched from the inside for superior access protection



Doors

- Vented or solid, to suit the individual climate control concept
- Mechanical and electronic lock systems for optimum security
- Door control systems to automatically open the doors in the event of a cooling failure or for room-based extinguisher systems



Base

- Individual base modules for optimum, secure cable entry from below
- Base/plinth systems with integral cable management solutions



IT infrastructure

Room integration

- Perfectly adapted modules for achieving cold or hot aisle solutions



Interior installation

With unlimited diversity

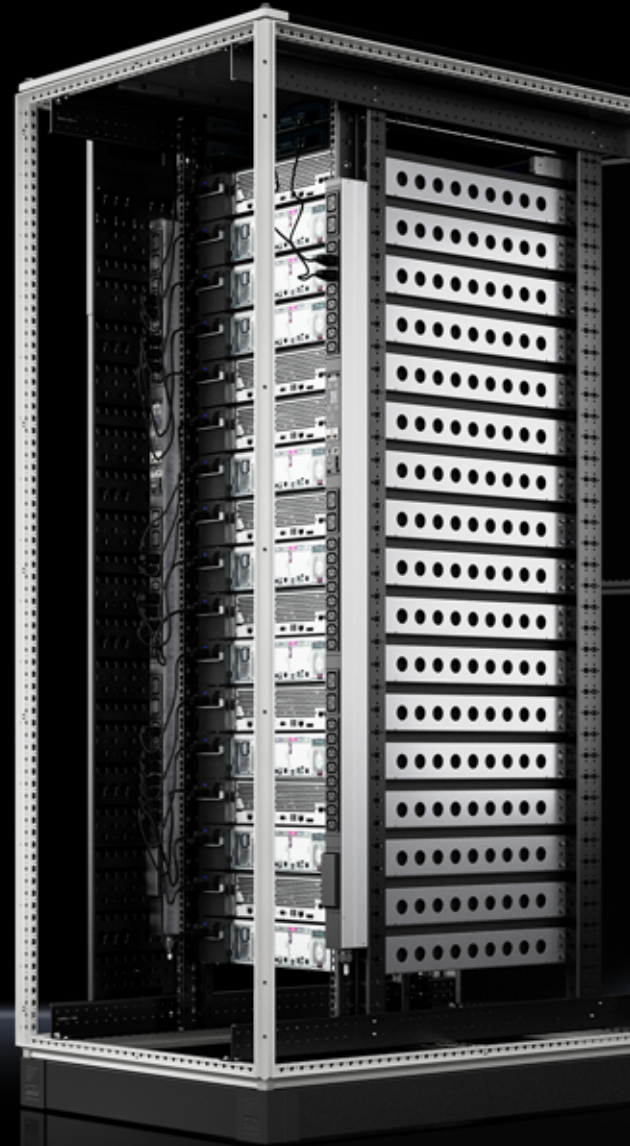



Power

- Wide range of socket strips and power distribution systems
- Power distribution unit in the zero-U space
- Professional monitoring and link to DCIM software (such as RiZone)
- Measurement of power, current, active and apparent power and power factor



Cooling

- Individual climate control concepts for rack, suite and room cooling up to 53 kW per rack
- Energy-efficient systems help to minimise operating costs



Monitoring

- CMC III enables preventive intervention to reduce the risk of downtime
- Mechanical and electronic lock systems for optimum security



Security

- Fire alarm and extinguisher systems for early fire detection and automatic extinguishing
- Door control systems to automatically open the doors in the event of a cooling failure and for room-based extinguisher systems



IT infrastructure

Interior installation

- Practical vertical and horizontal air routing inside the rack, even with a high density of ports
- Component shelves, for static or withdrawable installation
- Air blocking systems for optimum air routing inside the rack, adapted to the individual climate control concept



Network/server racks VX IT



Door variant, front	Vented door	Vented door	Vented door	
482.6 mm (19") configuration	standard	dynamic	standard	
Material thickness 482.6 mm (19") configuration variant, mm	2.0	2.5	2.0	
Load capacity, static N max., depending on size variant	15000	18000	15000	
Load capacity, static N max., to UL 2416, depending on size variant	12000	15000	12000	
Load capacity, dynamic N max., transport using castors, depending on size variant	10000	10000	10000	
Protection category to IEC 60 529	–	–	–	
Variants	53XX.11X	53XX.81X	53XX.166	

Product-specific scope of supply

Base	Open	■	■	–	
	Multi-piece, solid	–	–	–	
Rear door	One-piece, solid, 130° hinges	–	–	–	
	Vertically divided, from H ≥ 1800 mm, solid, 180° hinges	–	–	–	
	One-piece, vented, 130° hinges	■	■	–	
	Vertically divided, from H ≥ 1800 mm, vented, 180° hinges	■	■	■	
	Rear panel, screw-fastened	–	–	–	
Roof	With cable entry	■	■	■	
	Solid	–	–	–	

Pre-configured

Base/plinth	VX base/plinth, vented	–	–	■	
Base	Solid front, one base module as infill panel	–	–	■	
Walls	One-piece, screw-fastened	–	–	■	

Page	686	689	691	
------	-----	-----	-----	--

Network/server racks VX IT



	Glazed door standard	Glazed door dynamic	Glazed door standard	Glazed door standard	Glazed door swing frame	Glazed door without interior installation
	2.0	2.5	2.0	2.0	2.0	-
	15000	18000	15000	15000	3500	-
	12000	15000	12000	12000	3500	-
	10000	10000	10000	10000	3500	-
	-	-	IP 55	-	-	IP 55
	53XX.12X	53XX.82X	53XX.13X	53XX.15X	53XX.157	53XX.190
	■	■	-	-	-	-
	-	-	■	-	-	■
	■	■	■	■	-	■
	■	■	-	■	-	-
	-	-	-	-	-	-
	-	-	-	-	-	-
	-	-	-	-	■	-
	■	■	-	■	■	-
	-	-	■	-	-	■
	-	-	-	■	■	-
	-	-	-	■	■	-
	692	695	696	697	698	699

Network/server racks VX IT



IT power Page 723 **IT cooling** Page 757 **IT monitoring** Page 799 **System accessories** Page 877

Material:

- Sheet steel
- Aluminium

Surface finish:

- Enclosure frame: Dipcoat-primed
- Interior installation: Spray-finished
- Rear door and roof: Dipcoat-primed, powder-coated
- Front door: Aluminium, anodised/spray-finished

Colour:

- Enclosure frame, rear door and roof: RAL 7035
- Front door: Vertical sections, silver coloured and horizontal sections, RAL 9005
- Interior installation, vent grille at the front: RAL 9005
- Handle and hinges: RAL 9005

Supply includes:

- VX enclosure frame with doors and roof plate
- Aluminium/sheet steel door at the front, vented (vented surface area approx. 85% perforated), 180° hinges
- Sheet steel rear door, vented (vented surface area approx. 85% perforated)
- Lock front and rear: Comfort handle for profile half-cylinders and security lock 3524 E
- Spacers, height 50 mm, to raise the cover plate above the fan cut-out in the roof plate, for passive cooling (supplied loose)
- 12 x 482.6 mm (19") fastener, 1 U, conductive (supplied loose)
- 25 multi-tooth screws, conductive (supplied loose)
- IPPC pallet

Please observe the product-specific scope of supply.

Note:

- Depending on how and where it is sited, the door opening angle may vary for selected applications

Approvals:

- UL
- cUL

Network/server racks VX IT

with vented doors, with 482.6 mm (19") mounting angles, standard

Units U	Packs of	24	24	42	42	42	Page
Width mm		800	800	600	600	600	
Height mm		1200	1200	2000	2000	2000	
Depth mm		800	1000	600	800	1000	
Mounting position of the 482.6 mm (19") level(s)		front and rear	front and rear	front	front and rear	front and rear	
482.6 mm (19") attachment		on the cross-member, screw-fastened at the top and bottom	on depth stays, screw-fastened at the top and bottom	with mounting bracket screw-fastened to the frame at the top and bottom	with mounting bracket screw-fastened to the frame at the top and bottom	with mounting bracket screw-fastened to the frame at the top and bottom	
Max. load capacity (static) per enclosure N		8000	15000	7500	15000	15000	
Max. load capacity (static) per enclosure to UL 2416 N		8000	12000	6000	12000	12000	
Distance between prefitted 482.6 mm (19") levels mm		520	720	–	520	720	
Free mounting space to the 482.6 mm (19") level, front/rear mm		150 / 130	87 / 193	87 / 435	87 / 193	87 / 193	
Model No.	1 pc(s).	5303.114	5304.116	5329.111	5330.113	5308.113	
Product-specific scope of supply, roof plate							
Roof plate, multi-piece, with side cable entry in the depth, double-sided, prepared for fan mounting plate	1 pc(s).	■	■	–	–	–	
Roof plate, multi-piece, removable, for horizontal cable entry at the rear and with covered cut-out for fan mounting plate	1 pc(s).	–	–	■	–	–	
Roof plate, multi-piece, with cable entry in the corner sections front and rear	1 pc(s).	–	–	–	■	■	
Product-specific scope of supply, door							
Sheet steel door, vented, one-piece, 130° hinges	1 pc(s).	■	■	–	–	–	
Sheet steel rear door, vented, vertically divided, 180° hinges	1 pc(s).	–	–	■	■	■	
Accessories							
Side panel, screw-fastened, sheet steel	2 pc(s).	8175.245	8176.245	8106.245	8108.245	8100.245	901
Side panel, horizontally divided	1 pc(s).	–	–	–	–	5301.250	902
Baying connector, external, 3 mm	1 pc(s).	5301.310	5301.310	5301.310	5301.310	5301.310	914
Gland plate set, multi-piece, solid	1 pc(s).	5301.337	5301.344	–	–	5301.338	897

with vented doors, with 482.6 mm (19") mounting angles, standard

Units U	Packs of	42	42	42	42	47	Page
Width mm		600	800	800	800	600	
Height mm		2000	2000	2000	2000	2200	
Depth mm		1200	800	1000	1200	800	
Mounting position of the 482.6 mm (19") level(s)		front and rear	front and rear	front and rear	front and rear	front and rear	
482.6 mm (19") attachment		with mounting bracket screw-fastened to the frame at the top and bottom	on the cross-member, screw-fastened at the top and bottom	on depth stays, screw-fastened at the top and bottom	screw-fastened onto depth stays, top and bottom, and to the support rail on the frame structure	with mounting bracket screw-fastened to the frame at the top and bottom	
Max. load capacity (static) per enclosure N		15000	8000	15000	15000	15000	
Max. load capacity (static) per enclosure to UL 2416 N		12000	8000	12000	12000	12000	
Distance between prefitted 482.6 mm (19") levels mm		720	520	720	720	520	
Free mounting space to the 482.6 mm (19") level, front/rear mm		150 / 330	150 / 130	87 / 193	150 / 330	87 / 193	
Model No.	1 pc(s).	5310.118	5307.114	5309.116	5311.116	5331.113	
Product-specific scope of supply, roof plate							
Roof plate, multi-piece, with cable entry in the corner sections front and rear	1 pc(s).	■	–	–	–	■	
Roof plate, multi-piece, with side cable entry in the depth, double-sided, prepared for fan mounting plate	1 pc(s).	–	■	■	■	–	
Product-specific scope of supply, door							
Sheet steel rear door, vented, vertically divided, 180° hinges	1 pc(s).	■	■	■	■	■	
Accessories							
Side panel, screw-fastened, sheet steel	2 pc(s).	8102.245	8108.245	8100.245	8102.245	8128.245	901
Side panel, horizontally divided	1 pc(s).	5301.254	–	5301.250	5301.254	–	902
Baying connector, external, 3 mm	1 pc(s).	5301.310	5301.310	5301.310	5301.310	5301.310	914
Gland plate set, multi-piece, solid	1 pc(s).	5301.341	5301.337	5301.344	5301.347	–	897

Network/server racks VX IT

with vented doors, with 482.6 mm (19") mounting angles, standard

Units U	Packs of	47	47	47	47	47	Page
Width mm		600	600	800	800	800	
Height mm		2200	2200	2200	2200	2200	
Depth mm		1000	1200	800	1000	1200	
Mounting position of the 482.6 mm (19") level(s)		front and rear	front and rear	front and rear	front and rear	front and rear	
482.6 mm (19") attachment		with mounting bracket screw-fastened to the frame at the top and bottom	with mounting bracket screw-fastened to the frame at the top and bottom	on the cross-member, screw-fastened at the top and bottom	on depth stays, screw-fastened at the top and bottom	screw-fastened onto depth stays, top and bottom, and to the support rail on the frame structure	
Max. load capacity (static) per enclosure N		15000	15000	8000	15000	15000	
Max. load capacity (static) per enclosure to UL 2416 N		12000	12000	8000	12000	12000	
Distance between prefitted 482.6 mm (19") levels mm		720	720	520	720	720	
Free mounting space to the 482.6 mm (19") level, front/rear mm		87 / 193	150 / 330	150 / 130	87 / 193	150 / 330	
Model No.	1 pc(s).	5313.113	5315.118	5312.114	5314.116	5316.116	
Product-specific scope of supply, roof plate							
Roof plate, multi-piece, with cable entry in the corner sections front and rear	1 pc(s).	■	■	–	–	–	
Roof plate, multi-piece, with side cable entry in the depth, double-sided, prepared for fan mounting plate	1 pc(s).	–	–	■	■	■	
Product-specific scope of supply, door							
Sheet steel rear door, vented, vertically divided, 180° hinges	1 pc(s).	■	■	■	■	■	
Accessories							
Side panel, screw-fastened, sheet steel	2 pc(s).	8120.245	8122.245	8128.245	8120.245	8122.245	901
Side panel, horizontally divided	1 pc(s).	5301.257	5301.261	–	5301.257	5301.261	902
Baying connector, external, 3 mm	1 pc(s).	5301.310	5301.310	5301.310	5301.310	5301.310	914
Gland plate set, multi-piece, solid	1 pc(s).	5301.338	5301.341	5301.337	5301.344	5301.347	897



IT power Page 723 IT cooling Page 757 IT monitoring Page 799 System accessories Page 877

Material:

- Sheet steel
- Aluminium

Surface finish:

- Enclosure frame: Dipcoat-primed
- Interior installation: Spray-finished
- Rear door and roof: Dipcoat-primed, powder-coated
- Front door: Aluminium, anodised/spray-finished

Colour:

- Enclosure frame, rear door and roof: RAL 7035
- Front door: Vertical sections, silver coloured and horizontal sections, RAL 9005
- Interior installation, vent grille at the front: RAL 9005
- Handle and hinges: RAL 9005

Supply includes:

- VX enclosure frame with doors and roof plate
- Aluminium/sheet steel door at the front, vented (vented surface area approx. 85% perforated), 180° hinges
- Sheet steel rear door, vented (vented surface area approx. 85% perforated), vertically divided, 180° hinges
- Lock front and rear: Comfort handle for profile half-cylinders and security lock 3524 E
- Spacers, height 50 mm, to raise the cover plate above the fan cut-out in the roof plate, for passive cooling (supplied loose)
- 12 x 482.6 mm (19") fastener, 1 U, conductive (supplied loose)

- 25 multi-tooth screws, conductive (supplied loose)
 - IPPC pallet
- Please observe the product-specific scope of supply.

Note:

- Depending on how and where it is sited, the door opening angle may vary for selected applications

Approvals:

- UL
- cUL

with vented doors, with 482.6 mm (19") mounting angles, dynamic

Units U	Packs of	42	42	42	42	Page
Width mm		600	600	800	800	
Height mm		2000	2000	2000	2000	
Depth mm		1000	1200	1000	1200	
Mounting position of the 482.6 mm (19") level(s)		front and rear	front and rear	front and rear	front and rear	
482.6 mm (19") attachment		with mounting bracket screw-fastened to the frame at the top and bottom	with mounting bracket screw-fastened to the frame at the top and on depth stays at the bottom	on depth stays, screw-fastened at the top and bottom	on depth stays, screw-fastened at the top and bottom	
Max. load capacity (static) per enclosure N		18000	18000	18000	18000	
Max. load capacity (static) per enclosure to UL 2416 N		15000	15000	15000	15000	
Distance between prefitted 482.6 mm (19") levels mm		700	725	700	725	
Free mounting space to the 482.6 mm (19") level, front/rear mm		87 / 213	150 / 325	87 / 213	150 / 325	
Model No.	1 pc(s).	5308.813	5310.818	5309.816	5311.816	
Note on Model No.		-	-	-	-	
Product-specific scope of supply, roof plate						
Roof plate, multi-piece, with cable entry in the corner sections front and rear	1 pc(s).	■	■	-	-	
Roof plate, multi-piece, with side cable entry in the depth, double-sided, prepared for fan mounting plate	1 pc(s).	-	-	■	■	
Accessories						
Side panel, screw-fastened, sheet steel	2 pc(s).	8100.245	8102.245	8100.245	8102.245	901
Side panel, horizontally divided	1 pc(s).	5301.250	5301.254	5301.250	5301.254	902
Baying connector, external, 3 mm	1 pc(s).	5301.310	5301.310	5301.310	5301.310	914
Gland plate set, multi-piece, solid	1 pc(s).	5301.338	5301.341	5301.344	5301.347	897

Network/server racks VX IT

with vented doors, with 482.6 mm (19") mounting angles, dynamic

Units U	Packs of	47	47	47	47	Page
Width mm		600	600	800	800	
Height mm		2200	2200	2200	2200	
Depth mm		1000	1200	1000	1200	
Mounting position of the 482.6 mm (19") level(s)		front and rear	front and rear	front and rear	front and rear	
482.6 mm (19") attachment		with mounting bracket screw-fastened to the frame at the top and bottom	with mounting bracket screw-fastened to the frame at the top and on depth stays at the bottom	on depth stays, screw-fastened at the top and bottom	on depth stays, screw-fastened at the top and bottom	
Max. load capacity (static) per enclosure N		18000	18000	18000	18000	
Max. load capacity (static) per enclosure to UL 2416 N		15000	15000	15000	15000	
Distance between prefitted 482.6 mm (19") levels mm		700	725	700	725	
Free mounting space to the 482.6 mm (19") level, front/rear mm		87 / 213	150 / 325	87 / 213	150 / 325	
Model No.	1 pc(s).	5313.813	5315.818	5314.816	5316.816	
Note on Model No.		-	-	-	-	
Product-specific scope of supply, roof plate						
Roof plate, multi-piece, with cable entry in the corner sections front and rear	1 pc(s).	■	■	-	-	
Roof plate, multi-piece, with side cable entry in the depth, double-sided, prepared for fan mounting plate	1 pc(s).	-	-	■	■	
Accessories						
Side panel, screw-fastened, sheet steel	2 pc(s).	8120.245	8122.245	8120.245	8122.245	901
Side panel, horizontally divided	1 pc(s).	5301.257	5301.261	5301.257	5301.261	902
Baying connector, external, 3 mm	1 pc(s).	5301.310	5301.310	5301.310	5301.310	914
Gland plate set, multi-piece, solid	1 pc(s).	5301.338	5301.341	5301.344	5301.347	897

with vented doors, with 482.6 mm (19") mounting angles, dynamic

Units U	Packs of	52	52	52	52	Page
Width mm		600	600	800	800	
Height mm		2450	2450	2450	2450	
Depth mm		1000	1200	1000	1200	
Mounting position of the 482.6 mm (19") level(s)		front and rear	front and rear	front and rear	front and rear	
482.6 mm (19") attachment		with mounting bracket screw-fastened to the frame at the top and bottom	with mounting bracket screw-fastened to the frame at the top and on depth stays at the bottom	on depth stays, screw-fastened at the top and bottom	on depth stays, screw-fastened at the top and bottom	
Max. load capacity (static) per enclosure N		18000	18000	18000	18000	
Max. load capacity (static) per enclosure to UL 2416 N		15000	15000	15000	15000	
Distance between prefitted 482.6 mm (19") levels mm		700	725	700	725	
Free mounting space to the 482.6 mm (19") level, front/rear mm		87 / 213	150 / 325	87 / 213	150 / 325	
Model No.	1 pc(s).	5334.813	5332.818	5335.816	5333.816	
Note on Model No.		Minimum order quantity = 10 pc(s).	Minimum order quantity = 10 pc(s).	Minimum order quantity = 10 pc(s).	Minimum order quantity = 10 pc(s).	
Product-specific scope of supply, roof plate						
Roof plate, multi-piece, with cable entry in the corner sections front and rear	1 pc(s).	■	■	-	-	
Roof plate, multi-piece, with side cable entry in the depth, double-sided, prepared for fan mounting plate	1 pc(s).	-	-	■	■	
Accessories						
Side panel, screw-fastened, sheet steel		-	-	-	-	
Side panel, horizontally divided	1 pc(s).	5301.264	5301.265	5301.264	5301.265	902
Baying connector, external, 3 mm	1 pc(s).	5301.310	5301.310	5301.310	5301.310	914
Gland plate set, multi-piece, solid	1 pc(s).	5301.338	5301.341	5301.344	5301.347	897



IT power Page 723 IT cooling Page 757 IT monitoring Page 799 System accessories Page 877

Material:

- Sheet steel
- Aluminium
- Plastic

Surface finish:

- Enclosure frame: Dipcoat-primed
- Interior installation: Spray-finished
- Rear door and roof: Dipcoat-primed, powder-coated
- Front door: Aluminium, anodised/spray-finished

Colour:

- Enclosure frame, rear door and roof: RAL 7035
- Front door: Vertical sections, silver coloured and horizontal sections, RAL 9005
- Interior installation, vent grille at the front, base/plinth: RAL 9005
- Handle and hinges: RAL 9005

Supply includes:

- VX enclosure frame with doors and roof plate
- Aluminium/sheet steel door at the front, vented (vented surface area approx. 85% perforated), 180° hinges
- Sheet steel rear door, vented (vented surface area approx. 85% perforated), vertically divided, 180° hinges
- Lock front and rear: Comfort handle for profile half-cylinders and security lock 3524 E
- 482.6 mm (19") mounting angle, standard, variably screw-fastened to depth stays at the top and bottom
- Side panels, one-piece, for screw fastening
- Roof plate, multi-piece, with side cable entry in the depth, double-sided, prepared for fan mounting plate
- Base module mounted at front as infill panel
- Base/plinth system VX, 100 mm, vented
- Base/plinth corner pieces and trim panels, sides, screw-fastened
- Base/plinth trim panels, front and rear plus corner and bay-ing covers supplied loose
- 4 levelling feet, M12, including base/plinth adaptor (supplied loose)
- Spacers, height 50 mm, to raise the cover plate above the fan cut-out in the roof plate, for passive cooling (supplied loose)
- 12 x 482.6 mm (19") fastener, 1 U, conductive (supplied loose)
- 25 multi-tooth screws, conductive (supplied loose)
- 4 combination rails for inner and outer mounting level, to fit rack depth (supplied loose)
- 10 cable shunting rings, metal, 125 x 65 mm (supplied loose)
- IPPC pallet

Note:

- Depending on how and where it is sited, the door opening angle may vary for selected applications

Approvals:

- UL
- cUL

with vented doors, pre-configured, with 482.6 mm (19") mounting angles, standard

Units U	Packs of	42	Page
Width mm		800	
Height mm		2000	
Height including base/plinth mm		2100	
Depth mm		1000	
Max. load capacity (static) per enclosure N		15000	
Max. load capacity (static) per enclosure to UL 2416 N		12000	
Distance between prefitted 482.6 mm (19") levels mm		720	
Free mounting space to the 482.6 mm (19") level, front/rear mm		87 / 193	
Model No.	1 pc(s).	5309.166	
Accessories			
Fan mounting plate	1 pc(s).	5502.020	790
Cable route	1 pc(s).	5302.120	1066

Network/server racks VX IT



IT power Page 723 IT cooling Page 757 IT monitoring Page 799 System accessories Page 877

Material:

- Sheet steel
- Aluminium
- Glazed door: Single-pane safety glass, 3 mm

Surface finish:

- Enclosure frame: Dipcoat-primed
- Interior installation: Spray-finished
- Rear door and roof: Dipcoat-primed, powder-coated
- Front door: Aluminium, anodised/spray-finished

Colour:

- Enclosure frame, rear door and roof: RAL 7035
- Front door: Vertical sections, silver coloured and horizontal sections, RAL 9005
- Interior installation: RAL 9005
- Handle and hinges: RAL 9005

Supply includes:

- VX enclosure frame with doors and roof plate
- Glazed aluminium door at the front, 180° hinges
- Lock front and rear: Comfort handle for profile half-cylinders and security lock 3524 E

- Spacers, height 50 mm, to raise the cover plate above the fan cut-out in the roof plate, for passive cooling (supplied loose)
 - 12 x 482.6 mm (19") fastener, 1 U, conductive (supplied loose)
 - 25 multi-tooth screws, conductive (supplied loose)
 - IPPC pallet
- Please observe the product-specific scope of supply.

Note:

- Depending on how and where it is sited, the door opening angle may vary for selected applications

Approvals:

- UL
- cUL

with glazed door, with 482.6 mm (19") mounting angles, standard

Units U	Packs of	15	24	24	24	38	Page
Width mm		600	600	800	800	600	
Height mm		800	1200	1200	1200	1800	
Depth mm		600	600	800	1000	600	
Mounting position of the 482.6 mm (19") level(s)		front	front	front and rear	front and rear	front	
482.6 mm (19") attachment		with mounting bracket screw-fastened to the frame at the top and bottom	with mounting bracket screw-fastened to the frame at the top and bottom	on the cross-member, screw-fastened at the top and bottom	on depth stays, screw-fastened at the top and bottom	with mounting bracket screw-fastened to the frame at the top and bottom	
Max. load capacity (static) per enclosure N		7500	7500	8000	15000	7500	
Max. load capacity (static) per enclosure to UL 2416 N		6000	6000	8000	12000	6000	
Distance between prefitted 482.6 mm (19") levels mm		–	–	520	720	–	
Free mounting space to the 482.6 mm (19") level, front/rear mm		87 / 435	87 / 435	150 / 130	87 / 193	87 / 435	
Model No.	1 pc(s).	5325.121	5326.121	5303.124	5304.126	5327.121	
Product-specific scope of supply, roof plate							
Roof plate, multi-piece, with horizontal cable entry at the rear and prepared for fan mounting plate	1 pc(s).	■	■	–	–	■	
Roof plate, multi-piece, with side cable entry in the depth, double-sided, prepared for fan mounting plate	1 pc(s).	–	–	■	■	–	
Product-specific scope of supply, door							
Sheet steel rear door, solid, one-piece, 130° hinges	1 pc(s).	■	■	■	■	–	
Sheet steel rear door, solid, vertically divided, 180° hinges	1 pc(s).	–	–	–	–	■	
Accessories							
Side panel, screw-fastened, sheet steel	2 pc(s).	8173.245	8170.245	8175.245	8176.245	8186.245	901
Side panel, horizontally divided		–	–	–	–	–	
Baying connector, external, 3 mm	1 pc(s).	5301.310	5301.310	5301.310	5301.310	5301.310	914
Gland plate set, multi-piece, solid	1 pc(s).	–	–	5301.337	5301.344	–	897

Network/server racks VX IT

with glazed door, with 482.6 mm (19") mounting angles, standard

Units U	Packs of	38	38	42	42	Page
Width mm		600	800	600	600	
Height mm		1800	1800	2000	2000	
Depth mm		800	800	600	800	
Mounting position of the 482.6 mm (19") level(s)		front and rear	front and rear	front	front and rear	
482.6 mm (19") attachment		with mounting bracket screw-fastened to the frame at the top and bottom	on the cross-member, screw-fastened at the top and bottom	with mounting bracket screw-fastened to the frame at the top and bottom	with mounting bracket screw-fastened to the frame at the top and bottom	
Max. load capacity (static) per enclosure N		15000	8000	7500	15000	
Max. load capacity (static) per enclosure to UL 2416 N		12000	8000	6000	12000	
Distance between prefitted 482.6 mm (19") levels mm		520	520	-	520	
Free mounting space to the 482.6 mm (19") level, front/rear mm		87 / 193	150 / 130	87 / 435	87 / 193	
Model No.	1 pc(s).	5328.123	5305.124	5329.121	5330.123	
Product-specific scope of supply, roof plate						
Roof plate, multi-piece, with cable entry in the corner sections front and rear	1 pc(s).	■	-	-	■	
Roof plate, multi-piece, with side cable entry in the depth, double-sided, prepared for fan mounting plate	1 pc(s).	-	■	-	-	
Roof plate, multi-piece, with horizontal cable entry at the rear and prepared for fan mounting plate	1 pc(s).	-	-	■	-	
Product-specific scope of supply, door						
Sheet steel rear door, solid, vertically divided, 180° hinges	1 pc(s).	■	■	■	■	
Accessories						
Side panel, screw-fastened, sheet steel	2 pc(s).	8188.245	8188.245	8106.245	8108.245	901
Side panel, horizontally divided		-	-	-	-	
Baying connector, external, 3 mm	1 pc(s).	5301.310	5301.310	5301.310	5301.310	914
Gland plate set, multi-piece, solid	1 pc(s).	-	5301.337	-	-	897

with glazed door, with 482.6 mm (19") mounting angles, standard

Units U	Packs of	42	42	42	42	Page
Width mm		600	600	800	800	
Height mm		2000	2000	2000	2000	
Depth mm		1000	1200	600	800	
Mounting position of the 482.6 mm (19") level(s)		front and rear	front and rear	front	front and rear	
482.6 mm (19") attachment		with mounting bracket screw-fastened to the frame at the top and bottom	with mounting bracket screw-fastened to the frame at the top and bottom	on the cross-member, screw-fastened at the top and bottom	on the cross-member, screw-fastened at the top and bottom	
Max. load capacity (static) per enclosure N		15000	15000	4000	8000	
Max. load capacity (static) per enclosure to UL 2416 N		12000	12000	4000	8000	
Distance between prefitted 482.6 mm (19") levels mm		720	720	-	520	
Free mounting space to the 482.6 mm (19") level, front/rear mm		87 / 193	150 / 330	150 / 372	150 / 130	
Model No.	1 pc(s).	5308.123	5310.128	5306.122	5307.124	
Product-specific scope of supply, roof plate						
Roof plate, multi-piece, with cable entry in the corner sections front and rear	1 pc(s).	■	■	-	-	
Roof plate, multi-piece, with horizontal cable entry at the rear and prepared for fan mounting plate	1 pc(s).	-	-	■	-	
Roof plate, multi-piece, with side cable entry in the depth, double-sided, prepared for fan mounting plate	1 pc(s).	-	-	-	■	
Product-specific scope of supply, door						
Sheet steel rear door, solid, vertically divided, 180° hinges	1 pc(s).	■	■	■	■	
Accessories						
Side panel, screw-fastened, sheet steel	2 pc(s).	8100.245	8102.245	8106.245	8108.245	901
Side panel, horizontally divided	1 pc(s).	5301.250	5301.254	-	-	902
Baying connector, external, 3 mm	1 pc(s).	5301.310	5301.310	5301.310	5301.310	914
Gland plate set, multi-piece, solid	1 pc(s).	5301.338	5301.341	5301.336	5301.337	897

Network/server racks VX IT

with glazed door, with 482.6 mm (19") mounting angles, standard

Units U	Packs of	42	42	47	47	Page
Width mm		800	800	800	800	
Height mm		2000	2000	2200	2200	
Depth mm		1000	1200	800	1000	
Mounting position of the 482.6 mm (19") level(s)		front and rear	front and rear	front and rear	front and rear	
482.6 mm (19") attachment		on depth stays, screw-fastened at the top and bottom	screw-fastened onto depth stays, top and bottom, and to the support rail on the frame structure	on the cross-member, screw-fastened at the top and bottom	on depth stays, screw-fastened at the top and bottom	
Max. load capacity (static) per enclosure N		15000	15000	8000	15000	
Max. load capacity (static) per enclosure to UL 2416 N		12000	12000	8000	12000	
Distance between prefitted 482.6 mm (19") levels mm		720	720	520	720	
Free mounting space to the 482.6 mm (19") level, front/rear mm		87 / 193	150 / 330	150 / 130	87 / 193	
Model No.	1 pc(s).	5309.126	5311.126	5312.124	5314.126	
Product-specific scope of supply, roof plate						
Roof plate, multi-piece, with side cable entry in the depth, double-sided, prepared for fan mounting plate	1 pc(s).	■	■	■	■	
Product-specific scope of supply, door						
Sheet steel rear door, solid, vertically divided, 180° hinges	1 pc(s).	■	■	■	■	
Accessories						
Side panel, screw-fastened, sheet steel	2 pc(s).	8100.245	8102.245	8128.245	8120.245	901
Side panel, horizontally divided	1 pc(s).	5301.250	5301.254	–	5301.257	902
Baying connector, external, 3 mm	1 pc(s).	5301.310	5301.310	5301.310	5301.310	914
Gland plate set, multi-piece, solid	1 pc(s).	5301.344	5301.347	5301.337	5301.344	897

Network/server racks VX IT



IT power Page 723 IT cooling Page 757 IT monitoring Page 799 System accessories Page 877

Material:

- Sheet steel
- Aluminium
- Glazed door: Single-pane safety glass, 3 mm

Surface finish:

- Enclosure frame: Dipcoat-primed
- Interior installation: Spray-finished
- Rear door and roof: Dipcoat-primed, powder-coated
- Front door: Aluminium, anodised/spray-finished

Colour:

- Enclosure frame, rear door and roof: RAL 7035
- Front door: Vertical sections, silver coloured and horizontal sections, RAL 9005
- Interior installation: RAL 9005
- Handle and hinges: RAL 9005

Supply includes:

- VX enclosure frame with doors and roof plate
 - Glazed aluminium door at the front, 180° hinges
 - Sheet steel rear door, solid, vertically divided, 180° hinges
 - Lock front and rear: Comfort handle for profile half-cylinders and security lock 3524 E
 - Spacers, height 50 mm, to raise the cover plate above the fan cut-out in the roof plate, for passive cooling (supplied loose)
 - 12 x 482.6 mm (19") fastener, 1 U, conductive (supplied loose)
 - 25 multi-tooth screws, conductive (supplied loose)
 - IPPC pallet
- Please observe the product-specific scope of supply.

Note:

- Depending on how and where it is sited, the door opening angle may vary for selected applications

Approvals:

- UL
- cUL

with glazed door, with 482.6 mm (19") mounting angles, dynamic

Units U	Packs of	42	42	42	Page
Width mm		600	800	800	
Height mm		2000	2000	2000	
Depth mm		1000	1000	1200	
Mounting position of the 482.6 mm (19") level(s)		front and rear	front and rear	front and rear	
482.6 mm (19") attachment		with mounting bracket screw-fastened to the frame at the top and bottom	on depth stays, screw-fastened at the top and bottom	on depth stays, screw-fastened at the top and bottom	
Max. load capacity (static) per enclosure N		18000	18000	18000	
Max. load capacity (static) per enclosure to UL 2416 N		15000	15000	15000	
Distance between prefitted 482.6 mm (19") levels mm		700	700	725	
Free mounting space to the 482.6 mm (19") level, front/rear mm		87 / 213	87 / 213	150 / 325	
Model No.	1 pc(s).	5308.823	5309.826	5311.826	
Product-specific scope of supply, roof plate					
Roof plate, multi-piece, with cable entry in the corner sections front and rear	1 pc(s).	■	-	-	
Roof plate, multi-piece, with side cable entry in the depth, double-sided, prepared for fan mounting plate	1 pc(s).	-	■	■	
Accessories					
Side panel, screw-fastened, sheet steel	2 pc(s).	8100.245	8100.245	8102.245	901
Side panel, horizontally divided	1 pc(s).	5301.250	5301.250	5301.254	902
Baying connector, external, 3 mm	1 pc(s).	5301.310	5301.310	5301.310	914
Gland plate set, multi-piece, solid	1 pc(s).	5301.338	5301.344	5301.347	897

Network/server racks VX IT



IT power Page 723 IT cooling Page 757 IT monitoring Page 799 System accessories Page 877

Material:

- Sheet steel
- Aluminium
- Glazed door: Single-pane safety glass, 3 mm

Surface finish:

- Enclosure frame: Dipcoat-primed
- Interior installation: Spray-finished
- Rear door and roof: Dipcoat-primed, powder-coated
- Front door: Aluminium, anodised/spray-finished

Colour:

- Enclosure frame, rear door and roof: RAL 7035
- Front door: Vertical sections, silver coloured and horizontal sections, RAL 9005
- Interior installation: RAL 9005
- Handle and hinges: RAL 9005

Protection category IP to IEC 60 529:

- IP 55 only in conjunction with baying seal or screw-fastened side panels

Supply includes:

- VX enclosure frame with doors and roof plate
- Glazed aluminium door at the front, 180° hinges
- Sheet steel rear door, solid, one-piece, 130° hinges
- Lock front and rear: Comfort handle for profile half-cylinders and security lock 3524 E
- Roof plate, one-piece, solid
- Base tray with gland plate, multi-piece, solid
- Baying seal and sealing kit for gland plates (supplied loose)

- 12 x 482.6 mm (19") fastener, 1 U, conductive (supplied loose)
- 25 multi-tooth screws, conductive (supplied loose)
- IPPC pallet

Note:

- Depending on how and where it is sited, the door opening angle may vary for selected applications

Approvals:

- UL
- cUL

with glazed door, IP 55, with 482.6 mm (19") mounting angles, standard

Units U	Packs of	24	24	42	42	42	42	Page
Width mm		600	800	600	600	800	800	
Height mm		1200	1200	2000	2000	2000	2000	
Depth mm		600	800	600	800	800	1000	
Mounting position of the 482.6 mm (19") level(s)		front	front and rear	front	front and rear	front and rear	front and rear	
482.6 mm (19") attachment		with mounting bracket screw-fastened to the frame at the top and bottom	on the cross-member, screw-fastened at the top and bottom	with mounting bracket screw-fastened to the frame at the top and bottom	with mounting bracket screw-fastened to the frame at the top and bottom	on the cross-member, screw-fastened at the top and bottom	on depth stays, screw-fastened at the top and bottom	
Max. load capacity (static) per enclosure N		7500	8000	7500	15000	8000	15000	
Max. load capacity (static) per enclosure to UL 2416 N		6000	8000	6000	12000	8000	12000	
Distance between prefitted 482.6 mm (19") levels mm		-	520	-	520	520	720	
Free mounting space to the 482.6 mm (19") level, front/rear mm		87 / 435	150 / 130	87 / 435	87 / 193	150 / 130	87 / 193	
Model No.	1 pc(s).	5326.131	5303.134	5329.131	5330.133	5307.134	5309.136	
Accessories								
Side panel, screw-fastened, sheet steel	2 pc(s).	8170.245	8175.245	8106.245	8108.245	8108.245	8100.245	901
Baying connector, external	6 pc(s).	8617.502	8617.502	8617.502	8617.502	8617.502	8617.502	912
Combination rails	4 pc(s).	5302.020	5302.021	5302.020	5302.021	5302.021	5302.022	1063
Cable route	1 pc(s).	-	-	5302.120	5302.120	5302.120	5302.120	1066
Component shelf for frame attachment		see page	see page	see page	see page	see page	see page	1006



IT power Page 723 IT cooling Page 757 IT monitoring Page 799 System accessories Page 877

Material:

- Sheet steel
- Aluminium
- Plastic
- Glazed door: Single-pane safety glass, 3 mm

Surface finish:

- Enclosure frame: Dipcoat-primed
- Interior installation: Spray-finished
- Rear door and roof: Dipcoat-primed, powder-coated
- Front door: Aluminium, anodised/spray-finished

Colour:

- Enclosure frame, rear door and roof: RAL 7035
- Front door: Vertical sections, silver coloured and horizontal sections, RAL 9005
- Interior installation, base/plinth: RAL 9005
- Handle and hinges: RAL 9005

Supply includes:

- VX enclosure frame with doors and roof plate
- Glazed aluminium door at the front, 180° hinges
- Lock front and rear: Comfort handle for profile half-cylinders and security lock 3524 E
- Side panels, one-piece, screw-fastened
- Roof plate, multi-piece, with side cable entry in the depth, double-sided, prepared for fan mounting plate
- Base module mounted at front as infill panel
- Base/plinth system VX, 100 mm, vented
- Base/plinth corner pieces and trim panels, sides, screw-fastened
- Base/plinth trim panels, front and rear plus corner and bay-ing covers supplied loose

- 4 levelling feet, M12, including base/plinth adaptor (supplied loose)
 - Spacers to raise the fan cover plate, for passive cooling (supplied loose)
 - 12 x 482.6 mm (19") fastener, 1 U, conductive (supplied loose)
 - 25 multi-tooth screws, conductive (supplied loose)
 - 4 combination rails for inner and outer mounting level, to fit rack depth (supplied loose)
 - 10 cable shunting rings, metal, 125 x 65 mm (supplied loose)
 - IPPC pallet
- Please observe the product-specific scope of supply.

Note:

- Depending on how and where it is sited, the door opening angle may vary for selected applications

with glazed door, pre-configured, with 482.6 mm (19") mounting angles, standard

Units U	Packs of	24	42	42	Page
Width mm		800	800	800	
Height mm		1200	2000	2000	
Height including base/plinth mm		1300	2100	2100	
Depth mm		800	800	1000	
Mounting position of the 482.6 mm (19") level(s)		front and rear	front and rear	front and rear	
482.6 mm (19") attachment		on the cross-member, screw-fastened at the top and bottom	on the cross-member, screw-fastened at the top and bottom	on depth stays, screw-fastened at the top and bottom	
Max. load capacity (static) per enclosure N		8000	8000	15000	
Max. load capacity (static) per enclosure to UL 2416 N		8000	8000	12000	
Distance between prefitted 482.6 mm (19") levels mm		520	520	720	
Free mounting space to the 482.6 mm (19") level, front/rear mm		150 / 130	150 / 130	87 / 193	
Model No.	1 pc(s).	5303.154	5307.154	5309.156	
Product-specific scope of supply, door					
Sheet steel rear door, solid, one-piece, 130° hinges	1 pc(s).	■	-	-	
Sheet steel rear door, solid, vertically divided, 180° hinges	1 pc(s).	-	■	■	
Accessories					
Fan mounting plate	1 pc(s).	5502.020	5502.020	5502.020	790
Combination rails	4 pc(s).	5302.021	5302.021	5302.022	1063
Gland plate set, multi-piece, solid	1 pc(s).	5301.337	5301.337	5301.344	897
Castor module	2 pc(s).	5301.518	5301.518	5301.518	894

Network/server racks VX IT



IT power Page 723 IT cooling Page 757 IT monitoring Page 799 System accessories Page 877

Material:

- Sheet steel
- Aluminium
- Plastic
- Glazed door: Single-pane safety glass, 3 mm

Surface finish:

- Enclosure frame: Dipcoat-primed
- Interior installation: Spray-finished
- Rear panel and roof: Dipcoat-primed, powder-coated
- Front door: Aluminium, anodised/spray-finished

Colour:

- Enclosure frame, rear panel and roof: RAL 7035
- Front door: Vertical sections, silver coloured and horizontal sections, RAL 9005
- Interior installation, base/plinth: RAL 9005
- Handle and hinges: RAL 9005

Supply includes:

- VX enclosure frame with doors and roof plate
- Glazed aluminium door at the front (180°), with comfort handle for profile half-cylinders and security lock 3524 E
- Rear panel
- Roof plate, multi-piece, removable, with side cable entry in the depth and covered cut-out for fan mounting plate
- Base module mounted at front as infill panel
- Swing frame, large, with side trim panel for the installation of 482.6 mm (19") mounting components whilst utilising the full rack height, 130°
- Side panels, one-piece, for screw fastening
- Base/plinth system VX, 100 mm, vented
- Base/plinth corner pieces and trim panels, sides, screw-fastened
- Base/plinth trim panels, front and rear plus corner and bay-ing covers supplied loose
- 4 levelling feet, M12, including base/plinth adaptor (supplied loose)
- Spacers, height 50 mm, to raise the cover plate above the fan cut-out in the roof plate, for passive cooling (supplied loose)
- 12 x 482.6 mm (19") fastener, 1 U, conductive (supplied loose)
- 25 multi-tooth screws, conductive (supplied loose)
- 4 combination rails for inner and outer mounting level, to fit rack depth (supplied loose)
- 10 cable shunting rings, metal, 125 x 65 mm (supplied loose)
- IPPC pallet

Note:

- Depending on how and where it is sited, the door opening angle may vary for selected applications

Approvals:

- UL
- cUL

with glazed door, pre-configured, with 482.6 mm (19") swing frame

Width mm	Packs of	800	Page
Height mm		2000	
Height including base/plinth mm		2100	
Depth mm		800	
Max. load capacity (static) per enclosure N		3500	
Model No.	1 pc(s).	5307.157	
Accessories			
Fan mounting plate	1 pc(s).	5502.020	790
Combination rails	4 pc(s).	5302.021	1063
Cable route	1 pc(s).	5302.120	1066
Gland plate set, multi-piece, solid	1 pc(s).	5301.337	897



IT power Page 723 IT cooling Page 757 IT monitoring Page 799 System accessories Page 877

Material:

- Sheet steel
- Aluminium
- Glazed door: Single-pane safety glass, 3 mm

Surface finish:

- Enclosure frame: Dipcoat-primed
- Rear door and roof: Dipcoat-primed, powder-coated
- Front door: Aluminium, anodised/spray-finished

Colour:

- Enclosure frame, rear door and roof: RAL 7035
- Front door: Vertical sections, silver coloured and horizontal sections, RAL 9005
- Handle and hinges: RAL 9005

Protection category IP to IEC 60 529:

- IP 55 only in conjunction with baying seal or screw-fastened side panels

Supply includes:

- VX enclosure frame with doors and roof plate
- Glazed aluminium door at the front, 180° hinges
- Sheet steel rear door, solid, one-piece, 130° hinges
- Lock front and rear: Comfort handle for profile half-cylinders and security lock 3524 E
- Roof plate, one-piece, solid
- Base tray with gland plate, multi-piece, solid
- Baying seal and sealing kit for gland plates (supplied loose)

- 12 x 482.6 mm (19") fastener, 1 U, conductive (supplied loose)
- 25 multi-tooth screws, conductive (supplied loose)
- IPPC pallet

Note:

- Depending on how and where it is sited, the door opening angle may vary for selected applications

Approvals:

- UL
- cUL

with glazed door, IP 55, empty rack

Width mm	Packs of	600	600	600	600	600	600	Page
Height mm		800	1200	1800	1800	2000	2000	
Depth mm		600	600	600	800	1000	600	
Model No.	1 pc(s).	5325.190	5326.190	5327.190	5328.190	5308.190	5329.190	
Accessories								
Side panel, screw-fastened, sheet steel	2 pc(s).	8173.245	8170.245	8186.245	8188.245	8100.245	8106.245	901
Baying connector, external	6 pc(s).	8617.502	8617.502	8617.502	8617.502	8617.502	8617.502	912
Cable route	1 pc(s).	-	-	-	-	5302.120	5302.120	
Combination rails	4 pc(s).	5302.020	5302.020	5302.020	5302.021	5302.022	5302.020	1063
Component shelf for frame attachment		see page	see page	see page	see page	see page	see page	1006

with glazed door, IP 55, empty rack

Width mm	Packs of	600	600	800	800	800	Page
Height mm		2000	2200	2000	2000	2000	
Depth mm		800	800	600	800	1000	
Model No.	1 pc(s).	5330.190	5331.190	5306.190	5307.190	5309.190	
Accessories							
Side panel, screw-fastened, sheet steel	2 pc(s).	8108.245	8128.245	8106.245	8108.245	8100.245	901
Baying connector, external	6 pc(s).	8617.502	8617.502	8617.502	8617.502	8617.502	912
Cable route	1 pc(s).	5302.120	5302.122	5302.120	5302.120	5302.120	1066
Combination rails	4 pc(s).	5302.021	5302.021	5302.020	5302.021	5302.022	1063
Component shelf for frame attachment		see page	see page	see page	see page	see page	1006

Cable management enclosure

More space for network cabling



The cable management enclosure is the ideal solution when you need to manage large quantities of cables, especially surplus cables. Because it is fitted as standard with six punched sections with mounting flanges, the enclosure is perfectly equipped to accommodate a wide range of cable management systems. The cable management enclosure can also be used for the symmetrical balancing of cold/hot aisle containment.

The benefit to you:

- Optimum integration into VX IT rack suites, 2000 mm high and 1000 / 1200 mm deep
- Doors at the front and rear for easy access
- Fast cable entry in the base and roof section, thanks to integral brush strips



Cable management rack VX IT



Cable management Page 1044 **System accessories** Page 877 **IT monitoring** Page 799 **IT cooling** Page 757

For laying, securing and storing cables or as an empty enclosure with uneven Liquid Cooling Package (LCP) installations.

Applications:

- As a cable management rack between fully configured network and server racks
- As an empty rack for symmetrical balancing in cold/hot aisle containment with an uneven number of LCPs in two enclosure suites
- As a placeholder for easy retrofitting of LCP installations

Benefits:

- Optimum accommodation of surplus cables and structured cable management

Material:

- Sheet steel
- Aluminium

Surface finish:

- Enclosure frame: Dipcoat-primed
- Doors and roof: Dipcoat-primed, powder-coated

Colour:

- Enclosure: RAL 7035
- Front: RAL 9005

Supply includes:

- Enclosure frame with front and rear door
- Aluminium door, front, solid with black designer trim panel, 180° hinges
- Sheet steel rear door, solid, one-piece, 130° hinges
- Lock front and rear: Comfort handle for profile half-cylinders and security lock 3524 E
- 2 roof/base plates, with cut-outs for cable entry via brush strips
- 3 VX punched sections with mounting flanges mounted on the left and right
- Baying seal

Note:

- For positioning at the start/end of an enclosure suite, a side panel will be required

Width mm	Packs of	300	300	Page
Height mm		2000	2000	
Depth mm		1000	1200	
Model No.	1 pc(s).	5380.830	5381.830	
Accessories				
Side panel, horizontally divided	1 pc(s).	5301.250	5301.254	902
Baying connector, external, 3 mm	1 pc(s).	5301.310	5301.310	914
Combination rails	4 pc(s).	5302.022	5302.025	1063
Nylon tape holder	10 pc(s).	5502.155	5502.155	1062
Cable manager	20 pc(s).	5502.405	5502.405	1064
Cable shunting ring		see page	see page	1064
Cable clip		see page	see page	1060
Surplus cable holder	1 pc(s).	7220.500	7220.500	1066
Support	1 pc(s).	7246.500	7246.500	1097

Network racks TE 8000

Efficient and cost-effective



TE 8000 – the flexible network rack

- 482.6 mm (19") network rack, may be dismantled, which uses the 482.6 mm (19") level as its supporting structure
- By removing the doors and side panels, free access is available from all sides
- The entire interior is available to use for IT components, cabling and accessories
- Fast assembly, dismantling and conversion (dismantles fully for transporting to confined locations)



Comprehensive range of accessories for customised interior installation

- AX comfort handle with various lock options
- Brush strip for sealing the cable entries in the roof plate
- Depth-variable cable guide rail
- Universal interior installation with depth-variable attachment
- Direct installation on the 482.6 mm (19") mounting frame



System accessories for assembling a professional IT environment

- Power distribution system (PDU) in a range of sizes and functions
- Enclosure monitoring with the CMC III monitoring system
- Optimum cable management with the Network Cable Organizer (NCO)
- Cooling options for use in the network sector

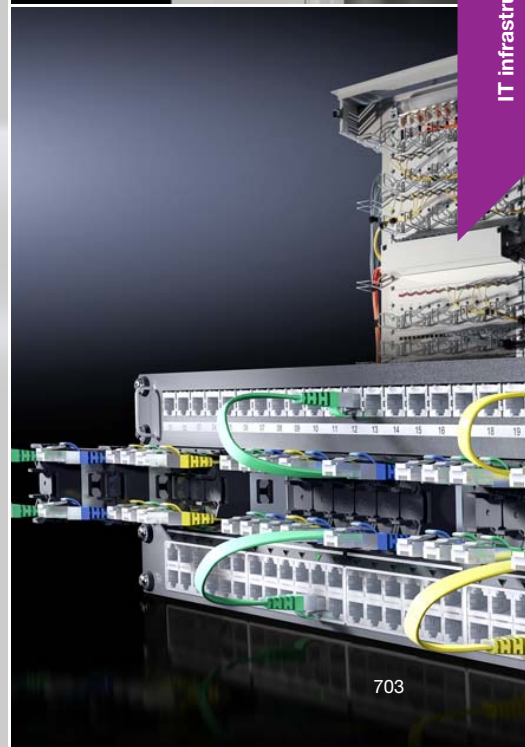

Network racks TE 8000



System accessories Page 877 **IT monitoring** Page 799 **IT cooling** Page 757 **IT power** Page 723

Benefits:

- No frame structure
- Optimum accessibility
- Readily dismantled and therefore easily installed
- Interchangeable door hinge

Material:

- Sheet steel
- Glazed door: Single-pane safety glass, 3 mm

Surface finish:

- Mounting frame: Dipcoat-primed
- Enclosure panels: Powder-coated

Colour:

- RAL 7035

Protection category IP to IEC 60 529:

- IP 20

Max. load capacity (static) per enclosure:

- 4000 N

Supply includes:

- Self-supporting 482.6 mm (19") mounting frames, front and rear, depth-variable
- Glazed door at the front, including 130° hinge, designer handle and security lock 3524 E
- Sheet steel door at the rear, including 130° hinge, security lock 3524 E
- Base frame with maximum cut-out (for optional population with module plates)

- Roof plate including concealed cut-out for cable entry and optional fan
 - 4 levelling feet, M10 (supplied loose)
 - 4 spacers, 20 mm (supplied loose) to raise the roof plate
- Please observe the product-specific scope of supply.

Width 600 mm

Units U	Packs of	11	11	24	24	42	42	Page
Width mm		600	600	600	600	600	600	
Height mm		600	600	1200	1200	2000	2000	
Depth mm		600	800	600	800	600	800	
Distance between prefitted 482.6 mm (19") levels mm		495	495	495	495	495	495	
Free mounting space to the 482.6 mm (19") level, front/rear mm		30 / 30	130 / 130	30 / 30	130 / 130	30 / 30	130 / 130	
Model No.	1 pc(s).	7888.390	7888.410	7888.430	7888.440	7888.500	7888.510	
Product-specific scope of supply								
Side panels, lockable, including security lock 3524 E	2 pc(s).	■	■	■	■	■	■	
Accessories								
482.6 mm (19") fastener, 1 U	24 pc(s).	2090.000	2090.000	2090.000	2090.000	2090.000	2090.000	1097
Side panel		-	-	-	-	-	-	
Baying kit	4 pc(s).	7888.640	7888.640	7888.640	7888.640	7888.640	7888.640	916
Brush kit	2 pc(s).	7888.610	7888.610	7888.610	7888.610	7888.610	7888.610	963
Fan mounting plate	1 pc(s).	5502.020	5502.020	5502.020	5502.020	5502.020	5502.020	790
Complete earthing kit	1 pc(s).	7000.675	7000.675	7000.675	7000.675	7000.675	7000.675	1036
Comfort handle AX	1 pc(s).	2435.100	2435.100	2435.100	2435.100	2435.100	2435.100	939
Component shelf, static installation	1 pc(s).	7000.620	7000.620	7000.620	7000.620	7000.620	7000.620	1008
Component shelf, pull-out	1 pc(s).	7000.625	7000.625	7000.625	7000.625	7000.625	7000.625	1009
Slide rail	2 pc(s).	7963.410	7963.410	7963.410	7963.410	7963.410	7963.410	1088
Socket strip in a plastic housing	1 pc(s).	7000.630	7000.630	7000.630	7000.630	7000.630	7000.630	1041

Width 800 mm

Units U	Packs of	24	42	42	42	Page
Width mm		800	800	800	800	
Height mm		1200	2000	2000	2000	
Depth mm		800	600	800	800	
Distance between prefitted 482.6 mm (19") levels mm		495	495	495	495	
Free mounting space to the 482.6 mm (19") level, front/rear mm		130 / 130	30 / 30	130 / 130	130 / 130	
Model No.	1 pc(s).	7888.460	7888.520	7888.530	7888.532	
Product-specific scope of supply						
Side panels, lockable, including security lock 3524 E	2 pc(s).	■	■	■	–	
Baying kit	4 pc(s).	–	–	–	■	
Accessories						
482.6 mm (19") fastener, 1 U	24 pc(s).	2090.000	2090.000	2090.000	2090.000	1097
Side panel	2 pc(s).	–	–	–	7888.652	903
Baying kit	4 pc(s).	7888.640	7888.640	7888.640	–	916
Brush kit	2 pc(s).	7888.612	7888.612	7888.612	7888.612	963
Fan mounting plate	1 pc(s).	5502.020	5502.020	5502.020	5502.020	790
Complete earthing kit	1 pc(s).	7000.675	7000.675	7000.675	7000.675	1036
Comfort handle AX	1 pc(s).	2435.100	2435.100	2435.100	2435.100	939
Component shelf, static installation	1 pc(s).	7000.620	7000.620	7000.620	7000.620	1008
Component shelf, pull-out	1 pc(s).	7000.625	7000.625	7000.625	7000.625	1009
Slide rail	2 pc(s).	7963.410	7963.410	7963.410	7963.410	1088
Socket strip in a plastic housing	1 pc(s).	7000.630	7000.630	7000.630	7000.630	1041

Rittal – The System.



Comfort handle AX

see page 939

Network racks TE 8000



System accessories Page 877 IT monitoring Page 799 IT cooling Page 757 IT power Page 723

Benefits:

- No frame structure
- Optimum accessibility
- Readily dismantled and therefore easily installed
- Interchangeable door hinge

Material:

- Enclosure: Sheet steel
- Glazed door: Single-pane safety glass, 3 mm

Surface finish:

- Mounting frame: Dipcoat-primed
- Enclosure panels: Powder-coated

Colour:

- RAL 7035

Protection category IP to IEC 60 529:

- IP 20

Max. load capacity (static) per enclosure:

- 4000 N

Supply includes:

- Self-supporting 482.6 mm (19") mounting frames, front and rear, depth-variable
- Glazed door at the front, including 130° hinge, designer handle and security lock 3524 E
- Sheet steel door at the rear, including 130° hinge, security lock 3524 E
- Side panels, lockable, including security lock 3524 E
- Base frame with maximum cut-out (for optional population with module plates)
- Roof plate including concealed cut-out for cable entry and optional fan
- 4 levelling feet, M12, including base/plinth adaptor (supplied loose)
- 4 spacers, 20 mm (supplied loose) to raise the roof plate
- Base/plinth system VX, 100 mm, vented
- Tested frame earthing to IEC 60 950, fitted
- 4 cable guide rails, for cable clamping in the enclosure depth via cable clamps (supplied loose)
- 10 cable shunting rings, metal, 125 x 65 mm (supplied loose)
- 12 x 482.6 mm (19") fastener, 1 U, conductive (supplied loose)
- 50 multi-tooth screws, conductive (supplied loose)
- Brush kit for cable entry in the roof (supplied loose)

Pre-configured

	Packs of	24	42	Page
Units U				
Width mm		800	800	
Height mm		1200	2000	
Height including base/plinth mm		1300	2100	
Depth mm		800	800	
Distance between prefitted 482.6 mm (19") levels mm		495	495	
Free mounting space to the 482.6 mm (19") level, front/rear mm		130 / 130	130 / 130	
Model No.	1 pc(s).	7888.840	7888.850	
Accessories				
482.6 mm (19") fastener, 1 U	24 pc(s).	2090.000	2090.000	1097
Baying kit	4 pc(s).	7888.640	7888.640	916
Fan mounting plate	1 pc(s).	5502.020	5502.020	790
Complete earthing kit	1 pc(s).	7000.675	7000.675	1036
Comfort handle AX	1 pc(s).	2435.100	2435.100	939
Component shelf, static installation	1 pc(s).	7000.620	7000.620	1008
Slide rail	2 pc(s).	7963.410	7963.410	1088
Complete CAT 6 system		see page	see page	1069
IT LED system light	1 pc(s).	7859.000	7859.000	1027
Socket strip in a plastic housing	1 pc(s).	7000.630	7000.630	1041



System accessories Page 877 Power System Module Page 744 IT monitoring Page 799 Climate control Page 449

Benefits:

- No frame structure
- Optimum accessibility
- Readily dismantled and therefore easily installed
- Interchangeable door hinge

Material:

- Sheet steel

Surface finish:

- Mounting frame: Dipcoat-primed
- Enclosure panels: Powder-coated

Colour:

- RAL 7035

Protection category IP to IEC 60 529:

- IP 20

Max. load capacity (static) per enclosure:

- 7000 N

Supply includes:

- Self-supporting 482.6 mm (19") mounting frames, front and rear, depth-variable
- Sheet steel door vented (vented surface area > 67%), front with designer handle, 130° hinge, security lock 3524 E
- Sheet steel door vented (vented surface area > 67%), rear with 130° hinge, security lock 3524 E
- Base frame with maximum cut-out (for optional population with module plates)

- Roof plate including concealed cut-out for cable entry and optional fan
 - 4 levelling feet, M10 (supplied loose)
 - 4 spacers, 20 mm (supplied loose) to raise the roof plate
- Please observe the product-specific scope of supply.

Vented

Units U	Packs of	24	42	42	Page
Width mm		600	600	800	
Height mm		1200	2000	2000	
Depth mm		1000	1000	1000	
Distance between prefitted 482.6 mm (19") levels mm		745	745	745	
Free mounting space to the 482.6 mm (19") level, front/rear mm		80 / 130	80 / 130	80 / 130	
Model No.	1 pc(s).	7888.875	7888.882	7888.892	
Product-specific scope of supply					
Side panels, lockable, including security lock 3524 E	2 pc(s).	■	-	-	
Baying kit	4 pc(s).	-	■	■	
Accessories					
482.6 mm (19") fastener, 1 U	24 pc(s).	2090.000	2090.000	2090.000	1097
Side panel	2 pc(s).	-	7888.653	7888.653	903
Baying kit	4 pc(s).	7888.640	-	-	916
Brush kit	2 pc(s).	7888.610	7888.610	7888.612	963
Complete earthing kit		see page	see page	see page	1036
Comfort handle AX	1 pc(s).	2435.100	2435.100	2435.100	939
Component shelf, static installation	1 pc(s).	5501.665	5501.665	5501.665	1008
Component shelf, pull-out	1 pc(s).	5501.685	5501.685	5501.685	1009
Slide rails, heavy-duty	2 pc(s).	7063.740	7063.740	7063.740	1087
Slide rail, 1 U, depth-variable	2 pc(s).	5302.035	5302.035	5302.035	1088
Combination rails	4 pc(s).	5302.020	5302.020	5302.020	1063
Cable clamp rail, depth-variable	1 pc(s).	5302.044	5302.044	5302.044	1063
Transport castors	4 pc(s).	7000.672	7000.672	7000.672	895
Socket strip in a plastic housing	1 pc(s).	7000.630	7000.630	7000.630	1041

Distributor racks

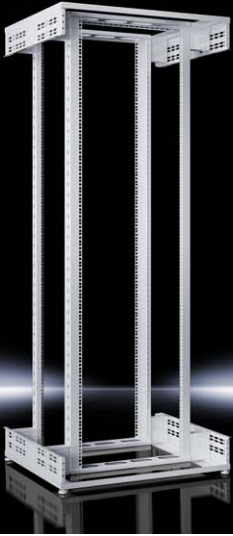

19" installation Page 1079 System accessories Page 877 TE 8000 Page 703

Benefits:

- Optimum accessibility from all sides during assembly and installation
- Unrestricted airflow, due to the open design
- The distance between attachment levels is infinitely variable

Material:

- Sheet steel

Surface finish:

- Powder-coated

Colour:

- RAL 7035

Max. load capacity (static) per enclosure:

- 7000 N

Supply includes:

- Self-supporting mounting frame, with 482.6 mm (19") mounting level front and rear
- Roof-plate, prepared for accommodating cable organisers
- Open base frame with 2 punched sections with mounting flanges for individual configuration fitted in the width
- 4 levelling feet, M10 (supplied loose)

Please observe the product-specific scope of supply.

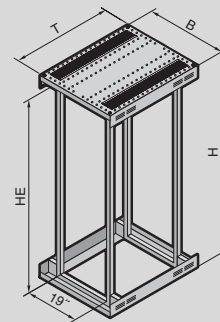

TE 8000 open

Units U	Packs of	42	42	Page
Width mm		600	800	
Height mm		2000	2000	
Depth mm		1000	1000	
Distance between prefitted 482.6 mm (19") levels mm		745	745	
Free mounting space to the 482.6 mm (19") level, front/rear mm		80 / 130	80 / 130	
Model No.	1 pc(s).	7888.940	7888.944	
Product-specific scope of supply				
Roof plate with brush strip, rear horizontal		■	–	
Roof plate with brush strip on both sides		–	■	
Accessories				
Cable organiser	4 pc(s).	7888.950	7888.950	963
482.6 mm (19") fastener, 1 U	24 pc(s).	2090.000	2090.000	1097
Component shelf, static installation	1 pc(s).	5501.665	5501.665	1008
Component shelf, pull-out	1 pc(s).	5501.685	5501.685	1008
Slide rails, heavy-duty	2 pc(s).	7063.740	7063.740	1087
Slide rail, 1 U, depth-variable	2 pc(s).	5302.035	5302.035	1088
Combination rails	4 pc(s).	5302.026	5302.026	1074
Cable route	1 pc(s).	7000.685	7000.685	1066
Cable duct	1 pc(s).	–	–	
Cable routing bars, 482.6 mm (19") attachment	4 pc(s).	7111.224	7111.224	1067
Shunting ring	4 pc(s).	–	7220.600	1064
Cable management panel		see page	see page	1072



19" installation Page 1079 IT monitoring Page 799 Power System Module Page 747 Accessories for Data Rack Page 1079

Material:

- Profile frame, base/plinth: Sheet steel
- Feet: Die-cast zinc

Colour:

- Profile frame, base/plinth: RAL 7035
- Trim panel, feet: RAL 5018

Max. load capacity (static) per 482.6 mm (19") level:

- 1500 N

Supply includes:

- Torsionally stiff profile frame with 482.6 mm (19") punchings
- Stable base/plinth with integral feet, with the option of floor anchoring without base trim panels
- Mounting accessories

Note:

- Order second mounting level separately

Photo shows a configuration example with equipment not included in the scope of supply

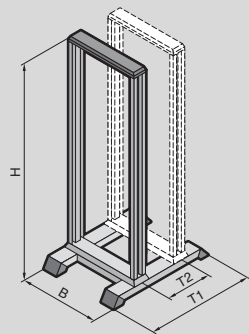

Data Rack

Units U	Packs of	31	36	40	45	Page
Width (B) mm		550	550	550	550	
Height (H) mm		1500	1722	1900	2122	
Depth (T1) mm		750	750	750	750	
Distance from the second mounting level, 50 mm pitch pattern (T2) mm		150 - 350	150 - 350	150 - 350	150 - 350	
Model No.	1 pc(s).	7391.000	7396.000	7400.000	7445.000	
Accessories						
Second pair of mounting angles	1 pc(s).	7296.000	7297.000	7298.000	7299.000	1079
Levelling feet		see page	see page	see page	see page	892
Twin castors	1 pc(s).	7495.000	7495.000	7495.000	7495.000	893
Baying clamp	3 pc(s).	7494.000	7494.000	7494.000	7494.000	1079
Support strips	2 pc(s).	7401.000	7401.000	7401.000	7401.000	1079
Component shelf, pull-out, 2 U	1 pc(s).	5501.635	5501.635	5501.635	5501.635	1010
Component shelf 2 U, static installation		see page	see page	see page	see page	1010
Slide rail, 2 U, static installation, continuous	2 pc(s).	7402.000	7402.000	7402.000	7402.000	1079
Slide rail		see page	see page	see page	see page	1079
Combination rails	4 pc(s).	5302.026	5302.026	5302.026	5302.026	1074
482.6 mm (19") fastener, 1 U	24 pc(s).	2090.000	2090.000	2090.000	2090.000	1097
Keyboard drawer 2 U	1 pc(s).	7281.035	7281.035	7281.035	7281.035	1115

Small IT racks series

Solutions for every application



VerticalBox – the ideal solution for small networks in office environments

- Compact wall-mounted, under-desk or desktop rack
- Free access from all sides to the 482.6 mm (19") level
- Door and side parts may be dismantled with no need for tools
- Passive ventilation as standard, fan may be retrofitted



FlatBox – the space-saving flat-pack solution

- 482.6 mm (19") rack for networks in office environments
- Supplied flat-packed, for easy and fast tool-free assembly
- May be used as wall-mounted or floor-standing enclosure, with free access from all sides
- Passive ventilation as standard, fan may be retrofitted



Wall-mounted enclosure EL, 3-part – optimum access to IT components

- Flexible wall-mounted enclosure in a range of designs and outputs
- Vertically hinged centre part for optimum access to IT equipment
- Suitable for industrial and IT applications
- High protection category up to IP 55



IT infrastructure

AX IT – for use in harsh environments

- Enclosure series to accommodate small IT components
- Data collection and distribution in industrial environments
- High protection category up to IP 66



VerticalBox



System accessories Page 877

Compact 482.6 mm (19") enclosure for small networks.

Benefits:

- May be used as wall-mounted, under-desk or desktop enclosure
- Free access from three sides for interior installation
- Passive ventilation with vent slots
- Rear panel prepared to accommodate a fan
- Freely selectable door hinging
- Space-saving, vertical mounting of 482.6 mm (19") installation components at the side

Material:

- Sheet steel
- Viewing window: Single-pane safety glass, 3 mm

Surface finish:

- Powder-coated

Colour:

- RAL 7035

Supply includes:

- Enclosure with glazed door
- Side panels (1 x fixed, 1 x slot-in) with vent slots
- Knockouts for cable entry via roof or base
- Slot-in rear panel with knockouts for cable entry and fan accommodation
- 482.6 mm (19") mounting level, 5 U, horizontal front and rear, depth-variable, distance between levels 434 – 489 mm
- Security lock 12321 on the door, side and rear panel
- 4 plastic feet, self-adhesive

Units U	Packs of	5	Page
Width mm		300	
Height mm		540	
Depth mm		600	
Model No.	1 pc(s).	7501.000	
Accessories			
482.6 mm (19") fastener, 1 U	24 pc(s).	2090.000	1097
Captive nuts	50 pc(s).	2094.500	1098
Assembly screws	50 pc(s).	7094.130	1098
IT LED system light	1 pc(s).	7859.000	1027
Brush strip	1 pc(s).	7072.200	1055
Complete earthing kit	1 pc(s).	7000.675	1036
Fan expansion kit	1 pc(s).	7980.100	790
Socket strip in a plastic housing	1 pc(s).	7000.630	1041
Socket strip for IEC 320 connectors	1 pc(s).	7240.200	1040
Socket strip in an aluminium duct		see page	1040
Blanking panel, 482.6 mm (19")		see page	1093
Cable management panel		see page	1072
Cable management panel with brush strip	1 pc(s).	5302.202	1074



System accessories Page 877

For flexible use as a wall-mounted or floor-standing enclosure.

Benefits:

- Tool-free quick assembly
- System assembly on the open 482.6 mm (19") frame

Material:

- Sheet steel
- Viewing window: Single-pane safety glass, 3 mm

Surface finish:

- Powder-coated

Colour:

- RAL 7035

Supply includes:

- Flat-packed enclosure
- 1 wall section
- 2 basic supports
- 2 roof/base plates, with cut-outs for cable entry via brush strips
- 2 side panels, lockable
- 1 glazed door, lockable, security lock 3524 E, door hinge point selectable
- Connection components for tool-free, fast assembly
- Earthing kit for system-compatible earthing of all enclosure parts

Please observe the product-specific scope of supply.

Note:

- Max. installation depth: Depth - 58 mm to rear panel
- Max. distance between two 482.6 mm (19") levels: Depth - 104 mm

Photo shows a configuration example with equipment not included in the scope of supply

Design with 482.6 mm (19") mounting angles

Units U	Packs of	6	6	9	9	Page
Width mm		600	600	600	600	
Height mm		358	358	492	492	
Depth mm		400	600	400	600	
Load capacity		max. 300 N	max. 300 N	max. 450 N	max. 450 N	
Model No.	1 pc(s).	7507.000	7507.100	7507.010	7507.110	
Product-specific scope of supply						
482.6 mm (19") mounting frame	1 pc(s).	■	■	■	■	
Accessories						
Base/plinth	1 pc(s).	–	7507.750	–	7507.750	891
Transport castors	4 pc(s).	7000.672	7000.672	7000.672	7000.672	895
Levelling feet	4 pc(s).	7507.740	7507.740	7507.740	7507.740	892
Mounting angles, 482.6 mm (19")	2 pc(s).	7507.706	7507.706	7507.709	7507.709	1085
482.6 mm (19") fastener, 1 U	24 pc(s).	2090.000	2090.000	2090.000	2090.000	1097
Component shelf, pull-out, 2 U	1 pc(s).	5501.635	5501.635	5501.635	5501.635	1010
Component shelf 2 U, static installation		see page	see page	see page	see page	1010
Component shelf, pull-out	1 pc(s).	–	5501.675	–	5501.675	1007
Cover plates for fan panels	6 pc(s).	7507.760	7507.760	7507.760	7507.760	791
Combination rails	4 pc(s).	5302.026	5302.026	5302.026	5302.026	1074
Fan expansion kit		see page	see page	see page	see page	790
Cable management panel	1 pc(s).	5502.205	5502.205	5502.205	5502.205	1072
Cable management panel with brush strip	1 pc(s).	5302.202	5302.202	5302.202	5302.202	1074
Earth rail, horizontal	1 pc(s).	7113.000	7113.000	7113.000	7113.000	1036
Thermostat	1 pc(s).	3110.000	3110.000	3110.000	3110.000	547

FlatBox

Design with 482.6 mm (19") mounting frame

Units U	Packs of	12	12	15	15	18	21	Page
Width mm		600	600	600	700	700	700	
Height mm		625	625	758	758	892	1025	
Depth mm		400	600	400	700	700	700	
Load capacity		max. 600 N	max. 600 N	max. 750 N	max. 750 N	max. 750 N	max. 750 N	
Model No.	1 pc(s).	7507.020	7507.120	7507.030	7507.200	7507.210	7507.220	
Product-specific scope of supply								
482.6 mm (19") mounting angles	2 pc(s).	■	■	■	■	■	■	
Accessories								
Base/plinth	1 pc(s).	–	7507.750	–	7507.755	7507.755	7507.755	891
Transport castors	4 pc(s).	7000.672	7000.672	7000.672	7000.672	7000.672	7000.672	895
Levelling feet	4 pc(s).	7507.740	7507.740	7507.740	7507.740	7507.740	7507.740	892
Mounting angles, 482.6 mm (19")	2 pc(s).	7507.712	7507.712	7507.715	7507.715	7507.718	7507.721	1085
482.6 mm (19") fastener, 1 U	24 pc(s).	2090.000	2090.000	2090.000	2090.000	2090.000	2090.000	1097
Component shelf, pull-out, 2 U	1 pc(s).	5501.635	5501.635	5501.635	5501.635	5501.635	5501.635	1010
Component shelf 2 U, static installation		see page	see page	see page	see page	see page	see page	1010
Component shelf, pull-out	1 pc(s).	–	5501.675	–	5501.675	5501.675	5501.675	1007
Cover plates for fan panels	6 pc(s).	7507.760	7507.760	7507.760	7507.760	7507.760	7507.760	791
Combination rails	4 pc(s).	5302.026	5302.026	5302.026	5302.026	5302.026	5302.026	1074
Fan expansion kit		see page	see page	see page	see page	see page	see page	790
Cable management panel	1 pc(s).	5502.205	5502.205	5502.205	5502.205	5502.205	5502.205	1072
Cable management panel with brush strip	1 pc(s).	5302.202	5302.202	5302.202	5302.202	5302.202	5302.202	1074
Earth rail, horizontal	1 pc(s).	7113.000	7113.000	7113.000	7113.000	7113.000	7113.000	1036
Thermostat	1 pc(s).	3110.000	3110.000	3110.000	3110.000	3110.000	3110.000	547

Rittal – The System.



IT infrastructure selector

www.rittal.com/it-configurator

Wall-mounted enclosures EL, 3-part



System accessories Page 877 **Socket strips** Page 1040 **Wall mounting bracket** Page 958 **Cable clamps** Page 1060

Wall-mounted enclosure with optimum accessibility due to hinged part.

Material:

- Wall and hinged part: Sheet steel, 1.5 mm
- Viewing window: Single-pane safety glass, 3 mm

Surface finish:

- Powder-coated

Colour:

- Wall and hinged part: RAL 7035
- Glazed door: RAL 7035/7015 (slate grey)

Protection category IP to IEC 60 529:

- IP 54 in conjunction with solid gland plate, top and bottom

Supply includes:

- Wall section with solid gland plate at the top and brush strip at the bottom, two vertical mounting rails and C rail, horizontal, for cable clamping
- Hinged part with 25 mm pitch pattern of holes in the front and rear frame, two 482.6 mm (19") mounting angles at the front, infinitely depth-variable, and side outlet filters on the left and right
- Earth rail with star earthing

- Designer glazed door
 - 1 double-kit key no. 5
- Please observe the product-specific scope of supply.

Approvals:

- UL
- cUL

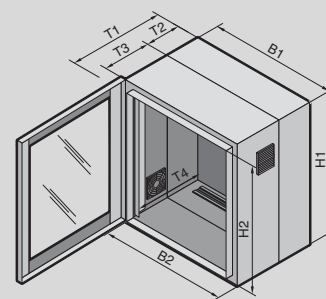

Pre-configured with mounting angles, depth-variable

Units U	Packs of	9	9	15	15	21	21	Page
Width (B1) mm		600	600	600	600	600	600	
Height (H1) mm		478	478	746	746	1012	1012	
Depth (T1) mm		573	673	573	673	573	673	
Clearance width (B2) mm		502	502	502	502	502	502	
Clearance height (H2) mm		415	415	683	683	949	949	
Depth of wall section (T2) mm		135	135	135	135	135	135	
Depth of hinged part (T3) mm		416	516	416	516	416	516	
Max. installation depth (T4) mm		520	620	520	620	520	620	
Load capacity of hinged part (static) N		450	450	750	750	750	750	
Model No.	1 pc(s).	7709.735	7709.535	7715.735	7715.535	7721.735	7721.535	
Product-specific scope of supply								
Wall mounting bracket, 10 mm	4 pc(s).	■	-	■	-	■	-	
Mini-comfort handle for lock inserts	1 pc(s).	■	■	■	■	-	-	
Security lock 3524 E	1 pc(s).	■	■	■	■	■	■	
Wall mounting bracket, 10 mm, reinforced	4 pc(s).	-	■	-	■	-	■	
Comfort handle for lock inserts and 2-point locking	1 pc(s).	-	-	-	-	■	■	
Accessories								
Gland plate for metric cable glands	1 pc(s).	7705.235	7705.235	7705.235	7705.235	7705.235	7705.235	1054
Fan expansion kit	1 pc(s).	7980.100	7980.100	7980.100	7980.100	7980.100	7980.100	790
Spare filter mat	5 pc(s).	3322.700	3322.700	3322.700	3322.700	3322.700	3322.700	535
Component shelf 2 U, static installation		see page	see page	see page	see page	see page	see page	1010
Cable management panel	1 pc(s).	7257.200	7257.200	7257.200	7257.200	7257.200	7257.200	1072
482.6 mm (19") fastener, 1 U	24 pc(s).	2090.000	2090.000	2090.000	2090.000	2090.000	2090.000	1097
Wall mounting bracket	4 pc(s).	2503.020	-	2503.020	-	2503.020	-	967

Wall-mounted enclosures EL, 3-part



System accessories Page 877 **Socket strips** Page 1040 **Wall mounting bracket** Page 958 **Earthing** Page 1033

Wall-mounted enclosure with optimum accessibility due to hinged part.

Material:

- Wall and hinged part: Sheet steel, 1.5 mm
- Viewing window: Single-pane safety glass, 3 mm

Surface finish:

- Powder-coated

Colour:

- Wall and hinged part: RAL 7035
- Glazed door: RAL 7035/7015 (slate grey)

Protection category IP to IEC 60 529:

- IP 55

Supply includes:

- Wall section with solid gland plate, top and bottom, two vertical mounting rails and C rail, horizontal, for cable clamping
 - Hinged part with 25 mm pitch pattern of holes in the front and rear frame, and two 482.6 mm (19") mounting angles at the front, infinitely depth-variable
 - 4 wall mounting brackets 10 mm
 - Designer glazed door
 - 1 double-kit key no. 5
- Please observe the product-specific scope of supply.

Approvals:

- UL
- cUL

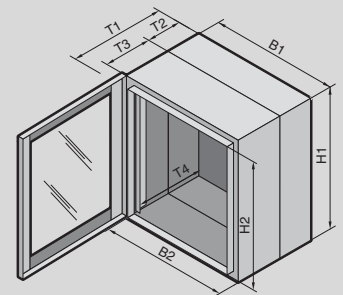

with punched rails and mounting angles, depth-variable

Units U	Packs of	6	9	12	15	21	Page
Width (B1) mm		600	600	600	600	600	
Height (H1) mm		345	478	612	746	1012	
Depth (T1) mm		473	473	473	473	473	
Clearance width (B2) mm		502	502	502	502	502	
Clearance height (H2) mm		282	415	549	683	949	
Depth of wall section (T2) mm		135	135	135	135	135	
Depth of hinged part (T3) mm		316	316	316	316	316	
Max. installation depth (T4) mm		420	420	420	420	420	
Load capacity of hinged part (static) N		300	450	600	750	750	
Model No.	1 pc(s).	7706.135	7709.135	7712.135	7715.135	7721.135	
Product-specific scope of supply							
Mini-comfort handle for lock inserts	1 pc(s).	■	■	■	■	-	
Security lock 3524 E	1 pc(s).	■	■	■	■	■	
Comfort handle for lock inserts and 2-point locking	1 pc(s).	-	-	-	-	■	
Accessories							
Gland plate with brush insert	1 pc(s).	7705.035	7705.035	7705.035	7705.035	7705.035	1055
Gland plate for metric cable glands	1 pc(s).	7705.235	7705.235	7705.235	7705.235	7705.235	1054
Earth rail, horizontal	1 pc(s).	7113.000	7113.000	7113.000	7113.000	7113.000	1036
Component shelf 2 U, static installation		see page	see page	see page	see page	see page	1010
Cable management panel	1 pc(s).	7257.200	7257.200	7257.200	7257.200	7257.200	1072
482.6 mm (19") fastener, 1 U	24 pc(s).	2090.000	2090.000	2090.000	2090.000	2090.000	1097
Component shelf, pull-out, 2 U	1 pc(s).	5501.635	5501.635	5501.635	5501.635	5501.635	1010

Wall-mounted enclosures EL, 3-part



System accessories Page 877 **Socket strips** Page 1040 **Wall mounting bracket** Page 958 **Cable clamps** Page 1060

Wall-mounted enclosure with optimum accessibility due to hinged part.

Material:

- Wall and hinged part: Sheet steel, 1.5 mm
- Viewing window: Single-pane safety glass, 3 mm

Surface finish:

- Powder-coated

Colour:

- Wall and hinged part: RAL 7035
- Glazed door: RAL 7035/7015 (slate grey)

Protection category IP to IEC 60 529:

- IP 55

Supply includes:

- Wall section with solid gland plate, top and bottom and mounting plate (supplied loose).
 - Hinged part with 25 mm pitch pattern of holes in the front and rear frame, and two 482.6 mm (19") mounting angles, front, static installation
 - Designer glazed door
 - 1 double-kit key no. 5
- Please observe the product-specific scope of supply.

Approvals:

- UL
- cUL

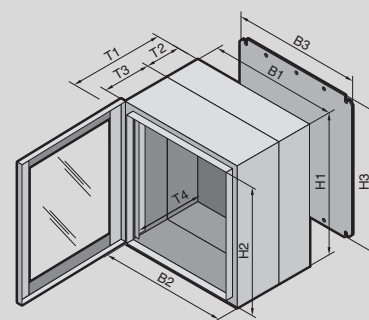

with mounting plate and mounting angles, static installation

Units U	Packs of	3	3	6	6	9	9	Page
Width (B1) mm		600	600	600	600	600	600	
Height (H1) mm		212	212	345	345	478	478	
Depth (T1) mm		373	473	373	473	373	473	
Clearance width (B2) mm		502	502	502	502	502	502	
Clearance height (H2) mm		149	149	282	282	415	415	
Depth of wall section (T2) mm		135	135	135	135	135	135	
Depth of hinged part (T3) mm		216	316	216	316	216	316	
Max. installation depth (T4) mm		320	420	320	420	320	420	
Mounting plate width (B3) mm		485	485	485	485	485	485	
Mounting plate height (H3) mm		165	165	299	299	432	432	
Load capacity of hinged part (static) N		150	150	300	300	450	450	
Model No.	1 pc(s).	2243.605	2253.605	2246.605	2256.605	2249.605	2259.605	
Product-specific scope of supply								
Mini-comfort handle for lock inserts	1 pc(s).	■	■	■	■	■	■	
Security lock 3524 E	1 pc(s).	■	■	■	■	■	■	
Accessories								
Gland plate with brush insert	1 pc(s).	7705.035	7705.035	7705.035	7705.035	7705.035	7705.035	1055
Gland plate for metric cable glands	1 pc(s).	7705.235	7705.235	7705.235	7705.235	7705.235	7705.235	1054
Wall mounting bracket		see page	see page	see page	see page	see page	see page	966
Component shelf 2 U, static installation		-	see page	-	see page	-	see page	1010
Blanking plate, 482.6 mm (19")		see page	see page	see page	see page	see page	see page	1092
Lock insert		see page	see page	see page	see page	see page	see page	941
482.6 mm (19") fastener, 1 U	24 pc(s).	2090.000	2090.000	2090.000	2090.000	2090.000	2090.000	1097
Component shelf, pull-out, 2 U	1 pc(s).	5501.635	5501.635	5501.635	5501.635	5501.635	5501.635	1010

Wall-mounted enclosures EL, 3-part

with mounting plate and mounting angles, static installation

Units U	Packs of	12	12	15	15	21	21	Page
Width (B1) mm		600	600	600	600	600	600	
Height (H1) mm		612	612	746	746	1012	1012	
Depth (T1) mm		373	473	373	473	373	473	
Clearance width (B2) mm		502	502	502	502	502	502	
Clearance height (H2) mm		549	549	683	683	949	949	
Depth of wall section (T2) mm		135	135	135	135	135	135	
Depth of hinged part (T3) mm		216	316	216	316	216	316	
Max. installation depth (T4) mm		320	420	320	420	320	420	
Mounting plate width (B3) mm		485	485	485	485	485	485	
Mounting plate height (H3) mm		565	565	699	699	965	965	
Load capacity of hinged part (static) N		600	600	750	750	750	750	
Model No.	1 pc(s).	2252.605	2262.605	2255.605	2265.605	2261.605	2271.605	
Product-specific scope of supply								
Mini-comfort handle for lock inserts	1 pc(s).	■	■	■	■	–	–	
Security lock 3524 E	1 pc(s).	■	■	■	■	■	■	
Comfort handle for lock inserts and 2-point locking	1 pc(s).	–	–	–	–	■	■	
Accessories								
Gland plate with brush insert	1 pc(s).	7705.035	7705.035	7705.035	7705.035	7705.035	7705.035	1055
Gland plate for metric cable glands	1 pc(s).	7705.235	7705.235	7705.235	7705.235	7705.235	7705.235	1054
Wall mounting bracket		see page	see page	see page	see page	see page	see page	967
Component shelf 2 U, static installation		–	see page	–	see page	–	see page	1010
Blanking plate, 482.6 mm (19")		see page	see page	see page	see page	see page	see page	1092
Lock insert		see page	see page	see page	see page	see page	see page	941
482.6 mm (19") fastener, 1 U	24 pc(s).	2090.000	2090.000	2090.000	2090.000	2090.000	2090.000	1097
Component shelf, pull-out, 2 U	1 pc(s).	5501.635	5501.635	5501.635	5501.635	5501.635	5501.635	1010

Rittal – The System.

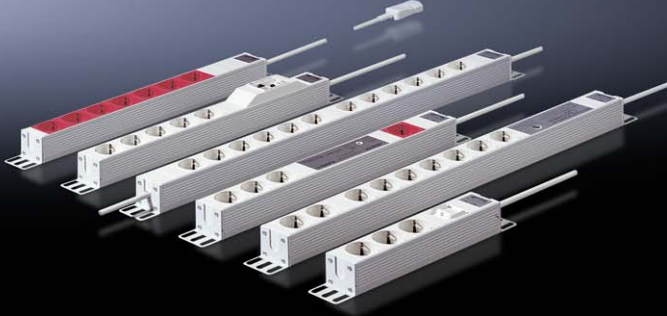

Socket strips

see page 1040

Wall-mounted enclosures AX IT



System accessories Page 877 **Socket strips** Page 1040 **Captive nuts** Page 1002 **Glazed doors** Page 926

IT wall-mounted enclosure based on AX, with high protection category, for use in industrial environments.

Applications:

- IT enclosure for use in industrial environments
- Secure, protected integration of IT directly into your production plant processes

Benefits:

- Fully pre-assembled IT enclosure for immediate accommodation of 482.6 mm (19") IT components, with depth-variable mounting angles
- Welded enclosure construction with all-round solid body ensures maximum protection for installed components, up to IP 66
- Door hinged on the right, may be swapped to the left
- Maximum usable interior volume with an extremely compact design
- Individual interior configuration
- Maximum cut-out in the enclosure base with optimised gland plates increases the space for cable routing by up to 33%
- Convenient cable entry from below via a gland plate with integral brush strip

Installation options:

- Pre-configured mounting bracket including C rail for cable clamping
- Mounting bracket to accommodate a central earth rail
- Mounting bracket for mounting a 482.6 mm (19") socket strip

Material:

- Sheet steel

Surface finish:

- Enclosure and door: Dipcoat primed, powder-coated on the outside, textured paint
- Interior installation: Zinc-plated

Colour:

- RAL 7035

Protection category IP to IEC 60 529:

- IP 10 (up to IP 66 on request)
- Up to IP 66 (depending on the selected gland plate)

Supply includes:

- Pre-assembled IT enclosure with hinged door, of all-round solid construction
- Cam lock with 3 mm double-bit insert
- Gland plate with brush strip
- 482.6 mm (19") mounting angle, front, mounted onto four interior installation rails with depth adjustment in 25 mm pitch pattern
- Mounting bracket
- C rail, fastened to the rear panel

Note:

- Variant with UL approval available on request

with 482.6 mm (19") mounting angles, depth-variable

Units U	Packs of	7	12	15	15	Page
Width mm		600	600	600	600	
Height mm		380	600	760	800	
Depth mm		350	350	350	400	
Max. installation depth mm		278	278	278	316	
Cam locks		1	2	2	2	
Model No.	1 pc(s).	7641.350	7643.350	7645.350	7646.400	
Gland plate, size		7	7	7	7	
Gland plate, qty.		1	1	1	1	

Accessories

Wall angle	4 pc(s).	2505.510	2505.510	2505.510	2505.510	967
Wall mounting bracket		see page	see page	see page	see page	967
Plastic gland plate	1 pc(s).	2567.200	2567.200	2567.200	2567.200	1050
Metal gland plate	1 pc(s).	2577.100	2577.100	2577.100	2577.100	1053
Plastic gland plate	1 pc(s).	2567.300	2567.300	2567.300	2567.300	1052
Component shelf, pull-out, 2 U	1 pc(s).	5501.635	5501.635	5501.635	5501.635	1010
Earth rail, horizontal	1 pc(s).	7113.000	7113.000	7113.000	7113.000	1036
Mini-comfort handle AX	1 pc(s).	2537.100	2537.100	2537.100	2537.100	940
482.6 mm (19") fastener, 1 U	24 pc(s).	2090.000	2090.000	2090.000	2090.000	1097
Cable management panel	1 pc(s).	5502.205	5502.205	5502.205	5502.205	1072
Cable management panel with brush strip	1 pc(s).	5302.202	5302.202	5302.202	5302.202	1074

Small fibre-optic distributor



System accessories Page 877

Benefits:

- Mounting plate with variable accommodation for up to two splicing cassettes (cassette width variable from 92 to 120 mm) and integral anti-twist guard
- Dividing plate with comb strip for cable clamping, to cover the splicing cassette, and to accommodate 2 patch panels
- Cable entry via prepunched knockouts using cable glands (2 x 22.5 mm and 12 x 12.5 mm)

Material:

- Enclosure with cover: Fibreglass-reinforced polycarbonate
- Cover screws: Polyamide
- Insulating bungs: Polyamide
- Foamed-in PU seal

Colour:

- RAL 7035

Protection category IP to IEC 60 529:

- IP 66

Supply includes:

- Enclosure with knockouts for cable glands
- Hinged cover with seal
- 2 cover screws, prepared for a lead seal
- Insulating bungs for wall mounting
- Mounting plate
- Dividing plate
- 12 cable glands M12 x 1.5
- 1 cable gland M20 x 1.5

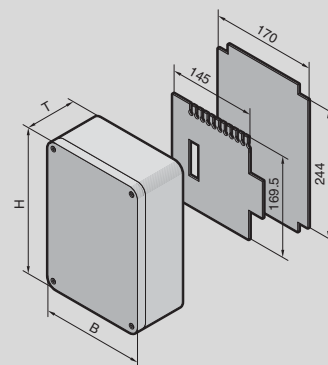

with mounting plate and splicing cassette accommodation

Width (B) mm	Packs of	180	Page
Height (H) mm		254	
Depth (T) mm		90	
Maximum number of fibres (when using patch panels)		24	
Model No.	1 pc(s).	7451.000	
Accessories			
Patch panels for small fibre-optic distributors		see page	1101
Wall mounting bracket	40 pc(s).	9583.000	47